

NTC Thermistor for Automotive: TTC3-C Series

Φ3 mm Lead Type for Temperature Sensing/Compensation



■ Structure and Dimensions

- Straight Lead

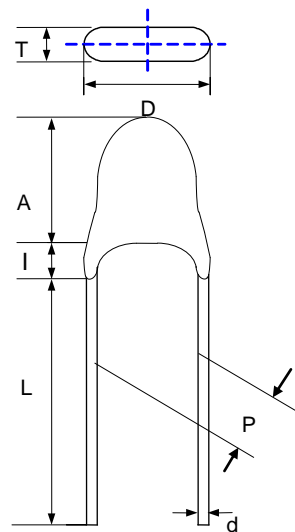

(Unit: mm)

Lead Type	P	D _{max.}	T _{max.}	A _{max.}	I _{max.}	L	d
Straight Lead	2.54±0.5	4	3	5	3	30~40	0.5±0.02

NTC Thermistor for Automotive: TTC3-C Series

Φ3 mm Lead Type for Temperature Sensing/Compensation



■ Electrical Characteristics

Part No.	Zero Power Resistance at 25°C	Tolerance of R ₂₅	B Value		Tolerance of B value	Max. Power Dissipation at 25°C	Dissipation Factor	Thermal Time Constant	Operating Temperature Range
	R ₂₅ (KΩ)	(±%)	(K)		(±%)	P _{max} (mW)	δ(mW/°C)	τ(Sec.)	T _L ~T _U (°C)
TTC3C202□39H*	2	1、2、3、5、10	25/85	3975	2	150	≥2.5	≤18	-55~+150
TTC3C302□39H*	3			3975	2				
TTC3C502□39H*	5			3975	1				
TTC3C103□34D*	10			3435	1				
TTC3C103□39H*	10			3975	1				
TTC3C303□410*	30			4100	2				
TTC3D474□520*	470		25/50	5200	3				

Note 1: □ = Tolerance of R₂₅
 * = Tolerance of B value

Note 2: Special specifications are available upon request.

■ Max. Power Dissipation Derating Curve

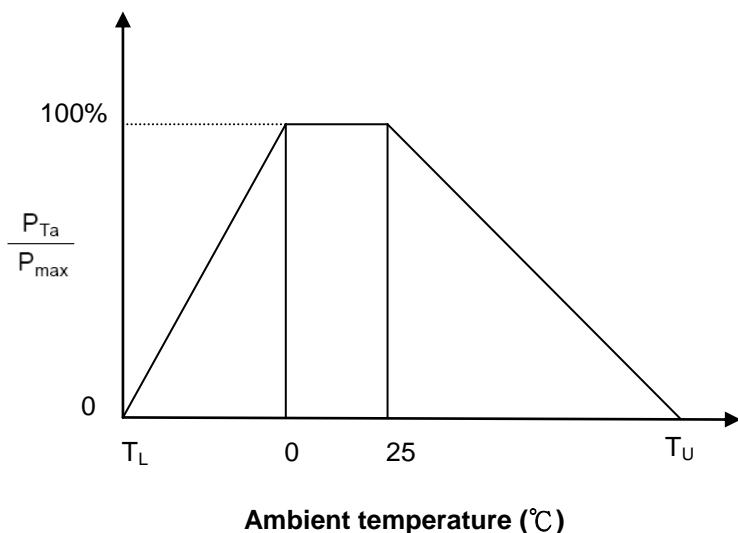

T_U : Maximum operating temperature (°C)

T_L : Minimum operating temperature (°C)

For example:

Ambient temperature(T_a) = 55°C

Maximum operating temperature(T_U) = 150°C

$P_{Ta} = (T_U - T_a) / (T_U - 25) \times P_{max} = 76\% P_{max}$

NTC Thermistor for Automotive: TTC3-C Series

Φ3 mm Lead Type for Temperature Sensing/Compensation



■ R-T Characteristic Curves

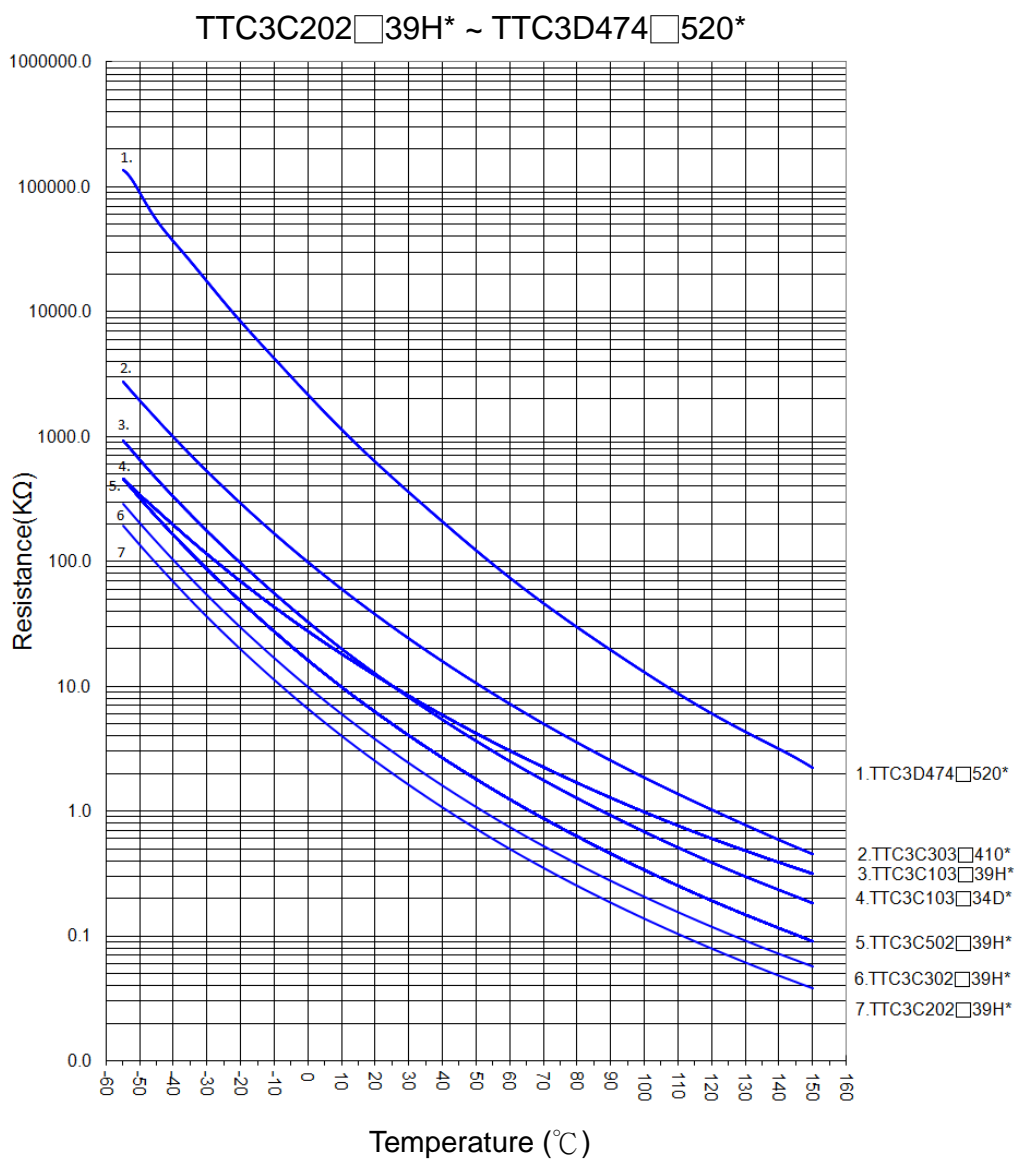

NTC Thermistor for Automotive: TTC3-C Series

Φ3 mm Lead Type for Temperature Sensing/Compensation



■ Soldering Recommendation

● Wave Soldering Profile

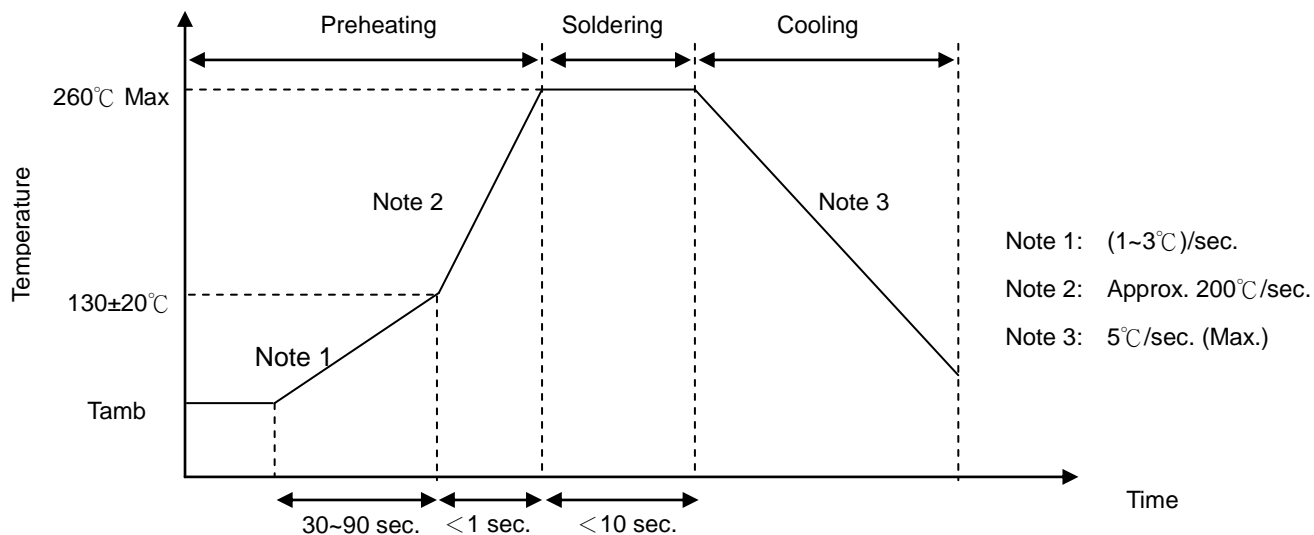

● Recommended Reworking Conditions with Soldering Iron

Item	Conditions
Temperature of Soldering Iron-tip	360°C (max.)
Soldering Time	3 sec. (max.)
Distance from Thermistor	2 mm (min.)

NTC Thermistor for Automotive: TTC3-C Series

Φ3 mm Lead Type for Temperature Sensing/Compensation



■ Reliability (based on AEC-Q200 Rev-D)

Item	Standard	Test conditions / Methods	Specifications
High Temperature Exposure	MIL-STD-202 Method 108	Test temp.: 150 +3/-0°C Duration: 1000 h Unpowered Measurement at 24±2 hours after test conclusion.	No visible damage $\Delta R_{25}/R_{25}$ $\leq 5\%$
Temperature Cycling	JESD22 Method JA-104	1000 Cycles (-55°C to +125°C) Measurement at 24±2 hours after test conclusion. 30min maximum dwell time at each temperature extreme. 1 min. maximum transition time.	No visible damage $\Delta R_{25}/R_{25}$ $\leq 5\%$
Biased Humidity	MIL-STD-202 Method 103	1000 hours 85°C/85%RH.1mW power. Measurement at 24±2 hours after test conclusion	No visible damage $\Delta R_{25}/R_{25}$ $\leq 5\%$
Operational Life	MIL-STD-202 Method 108	Test temp.: 150 +3/-0°C Duration: 1000 h. 1mW power. Measurement at 24±2 hours after test conclusion.	No visible damage $\Delta R_{25}/R_{25}$ $\leq 5\%$
External Visual	MIL-STD-883 Method 2009	Inspect device construction, marking and workmanship. Electrical Test not required.	No visible damage $\Delta R_{25}/R_{25}$ $\leq 5\%$
Physical Dimension	JESD22 Method JB-100	Verify physical dimensions to the applicable device specification.	No visible damage $\Delta R_{25}/R_{25}$ $\leq 5\%$
Terminal Strength(Leaded)	MIL-STD-202 Method 211	Test leaded device lead integrity only. Conditions: C (227 g).	No visible damage
Resistance to Solvents	MIL-STD-202 Method 215	Also aqueous wash chemical - OKEM Clean or equivalent. Do not use banned solvents.	No visible damage $\Delta R_{25}/R_{25}$ $\leq 5\%$
Mechanical Shock	MIL-STD-202 Method 213	Figure 1 of Method 213 LEADED:Condition C	No visible damage $\Delta R_{25}/R_{25}$ $\leq 5\%$
Vibration	MIL-STD-202 Method 204	5 g's for 20 minutes, 12 cycles each of 3 orientations. Note: Use 8"X5" PCB .031" thick with 7 secure points on one 8" side and 2 secure points on corners of opposite sides. Parts mounted within 2" from any secure point. Test from 10-2000 Hz.	No visible damage $\Delta R_{25}/R_{25}$ $\leq 5\%$
Resistance to Solder Heat	MIL-STD-202 Method 210	260+/-5°C 10+/-1s,25mm/s+/-6mm/s, 1cycle.	No visible damage $\Delta R_{25}/R_{25}$ $\leq 5\%$
ESD	AEC-Q200-002	Discharge capacitance : 150 pF Charging voltage: 6 kV ,Contact discharge 1 pulse in each polarity	No visible damage $\Delta R_{25}/R_{25}$ $\leq 5\%$
Solderability	IEC 60068-2-58 J-STD-002	Dipping Method Temperature : 235±5°C Time : 2±0.5sec	95% of termination wetted

NTC Thermistor for Automotive: TTC3-C Series

Φ3 mm Lead Type for Temperature Sensing/Compensation



■ Reliability (based on AEC-Q200 Rev-D)

Item	Standard	Test conditions / Methods	Specifications
Electrical Characterization	User Spec	R(-40°C)/ R(25°C)/ R(150°C) B25/85 or B25/50	Within the Specified values
Flammability	UL-94	V-0 or V-1 are acceptable. Electrical test not required.	V-0 or V-1 are acceptable.

■ Packaging

● Taping Specification

Straight Lead

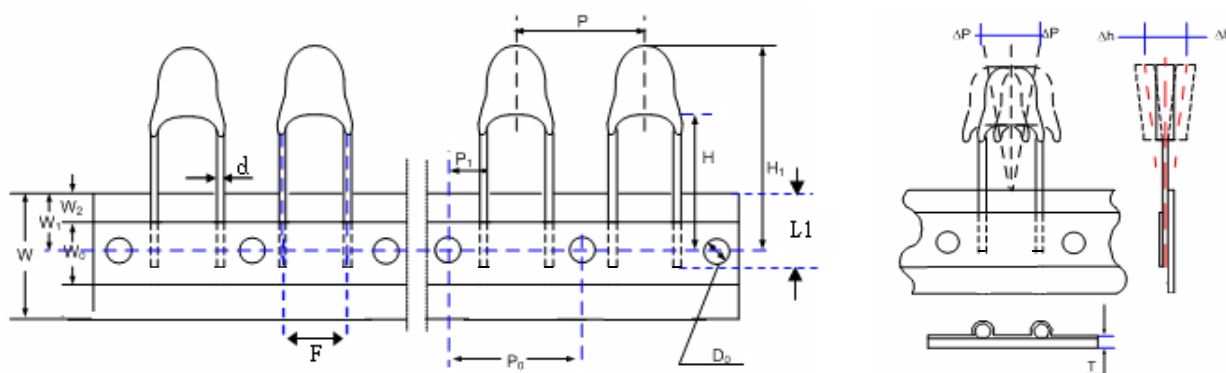

T (Unit:mm)

Taping Dimension	P ₀	F	P	P ₁	H ₀	H ₁	d	W ₀	W ₁	W ₂	W	ΔP	Δh	L ₁	D ₀	T
	±0.3	±0.5	±1	±0.7	+2/-0	Max.	±0.02	±1	+0.75 /-0.5	Max.	+1/ -0.5	Max.	Max.	±1.	±0.2	±0.2
P ₀ =12.7	12.7	2.54	12.7	5.08	18	25	0.5	12	9	3	18	1	2	10	4	0.6

NTC Thermistor for Automotive: TTC3-C Series

Φ3 mm Lead Type for Temperature Sensing/Compensation



Quantity

● Bulk Packing

Series	Quantity (pcs/bag)
TTC3	500

● Reel Packing

Series	Quantity (pcs/reel)
TTC3	2,500

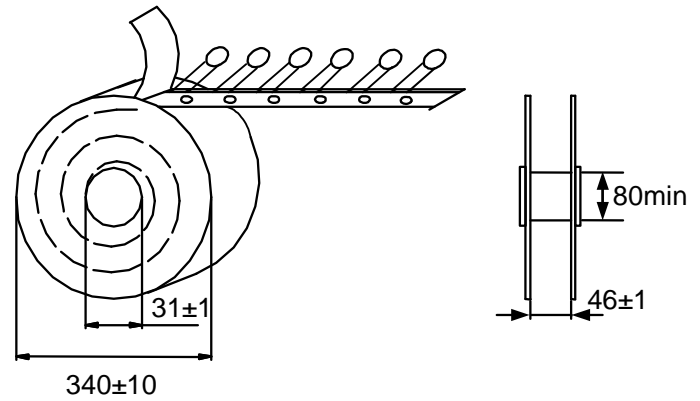

(Unit: mm)

● Ammo Packing

Series	Quantity (pcs/box)
TTC3	2,500

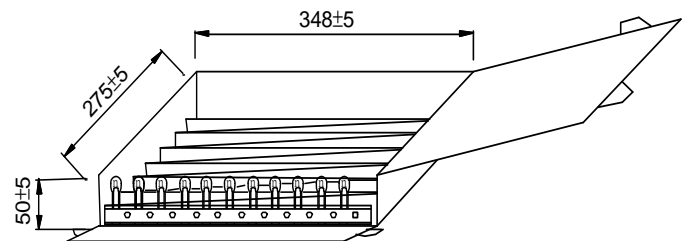

Warehouse Storage Conditions of Products

● Storage Conditions:

1. Storage Temperature: $-10^{\circ}\text{C} \sim +40^{\circ}\text{C}$
2. Relative Humidity: $\leq 75\% \text{RH}$
3. Keep away from corrosive atmosphere and sunlight.

● Period of Storage : 1 year