

# Gas Discharge Tube: GB83R Series



## 3-Electrode $\Phi 8.0 \times T10$ mm Type

### ■ Features

1. RoHS & HF compliant
2. Rugged ceramic-metal construction
3. Available with or without leads
4. Available with fail-safe clip
5. DC spark-over voltage: 90~600V
6. Low capacitance
7. Agency recognition: UL
8. Operating temperature:  $-40^{\circ}\text{C} \sim +105^{\circ}\text{C}$   
Storage temperature:  $-40^{\circ}\text{C} \sim +115^{\circ}\text{C}$



### ■ Recommended Applications

1. Cable modem
2. xDSL
3. Set-top box
4. TV sets
5. Power supply
6. Consumer electronics

### ■ Part Number Code

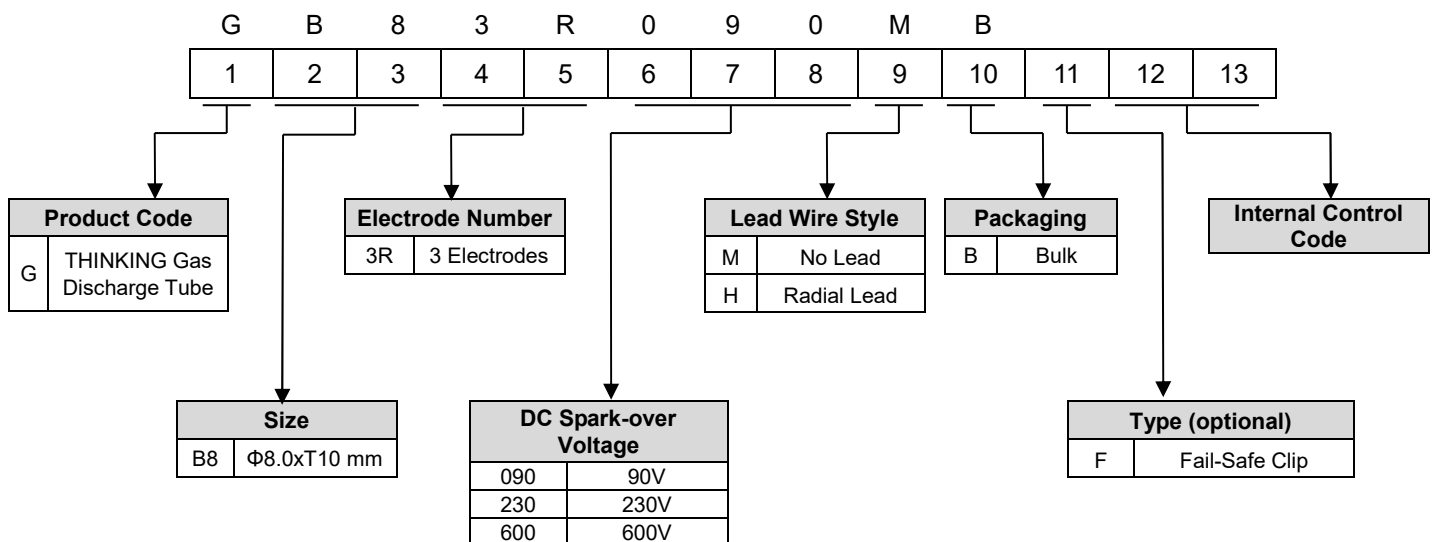

# Gas Discharge Tube: GB83R Series



## 3-Electrode $\Phi 8.0$ x T10 mm Type

### ■ Characteristics

Part No.	DC Spark-over Voltage	Max. Impulse Breakdown Voltage		Max. Impulse Discharge Current (8/20 $\mu$ s)	Impulse Life (10/1000 $\mu$ s)	Normal Alternating Discharge Current	DC Holdover Voltage	Minimum Insulation Resistance	Maximum Capacitance (1MHz)	Safety Approvals
	100V/S	100V/ $\mu$ s	1KV/ $\mu$ s	10 times	200 A	50Hz, 1Sec	<150ms			
	(V)	(V)	(V)	(KA)	Times	(A)	(V)			
GB83R090□□(F)	90 $\pm$ 20%	600	700	20	130	20	52	10	2	√
GB83R145□□(F)	145 $\pm$ 20%	500	700				52			√
GB83R200□□(F)	200 $\pm$ 20%	500	700				135			√
GB83R230□□(F)	230 $\pm$ 20%	600	700				135			√
GB83R250□□(F)	250 $\pm$ 20%	600	700				135			√
GB83R350□□(F)	350 $\pm$ 20%	700	800				150			√
GB83R400□□(F)	400 $\pm$ 20%	800	900				150			√
GB83R470□□(F)	470 $\pm$ 20%	900	1000				150			√
GB83R600□□(F)	600 $\pm$ 20%	1000	1100				150			√

Note1 : The first □ is style of lead wire, the second □ is packaging.

Note2 : F = With fail-safe clip for optional.

Note 3: UL 497B File No: E245070

Note 4: Insulation resistance test conditions:

DC Spark-over Voltage	DC Measuring Voltage
90-150V	50V
151-400V	100V
401-600V	250V

# Gas Discharge Tube: GB83R Series



## 3-Electrode $\Phi 8.0 \times T10$ mm Type

### ■ Dimensions

□ = H (Radial Lead Type)

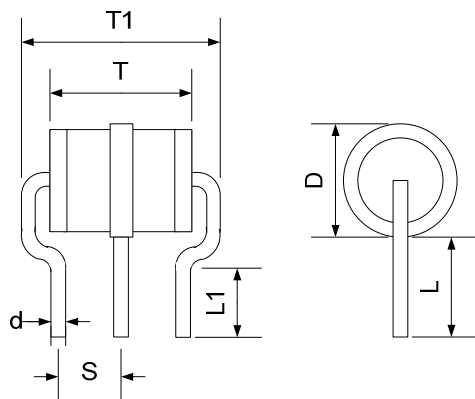

(Unit: mm)

Item	Dimensions	
	Spec.	Tolerance
D	8.0	+0.2/-0.8
T	10.0	$\pm 0.5$
T1	13.4	+0.8/-0.5
L	7.5	$\pm 0.5$
L1	4.5	Min
S	4.4	$\pm 0.4$
d	1.0	$\pm 0.05$

□ = M (No Lead Type)

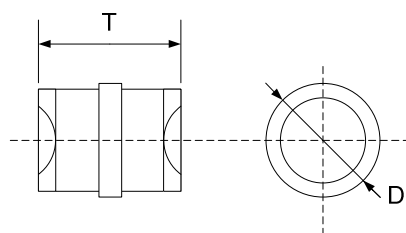

(Unit: mm)

Item	Dimensions	
	Spec.	Tolerance
D	8.0	+0.2/-0.8
T	10.0	$\pm 0.5$

F = with fail-safe clip for optional

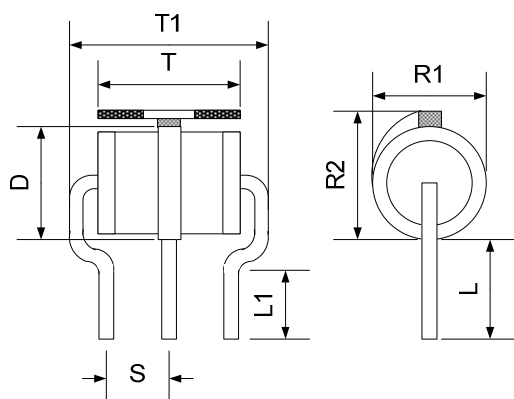

(Unit: mm)

Item	Dimensions	
	Spec.	Tolerance
D	8.0	+0.2/-0.8
T	10.0	$\pm 0.5$
R1	8.1	$\pm 0.3$
R2	9.8	$\pm 0.4$
T1	13.4	+0.8/-0.5
L	7.5	$\pm 0.5$
L1	4.5	Min
S	4.4	$\pm 0.4$
d	1.0	$\pm 0.05$

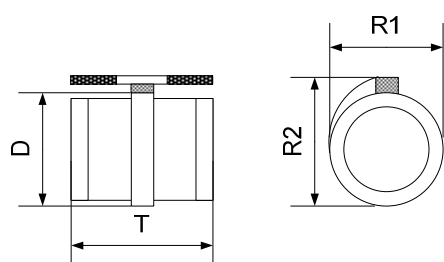

(Unit: mm)

Item	Dimensions	
	Spec.	Tolerance
D	8.0	+0.2/-0.8
T	10.0	$\pm 0.5$
R1	8.1	$\pm 0.3$
R2	9.8	$\pm 0.4$

# Gas Discharge Tube: GB83R Series



## 3-Electrode $\Phi 8.0$ x T10 mm Type

### ■ Marking

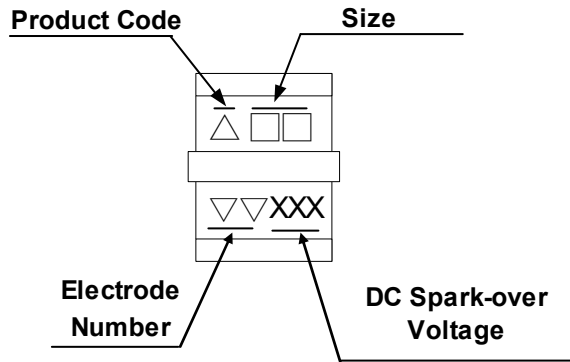

#### Example

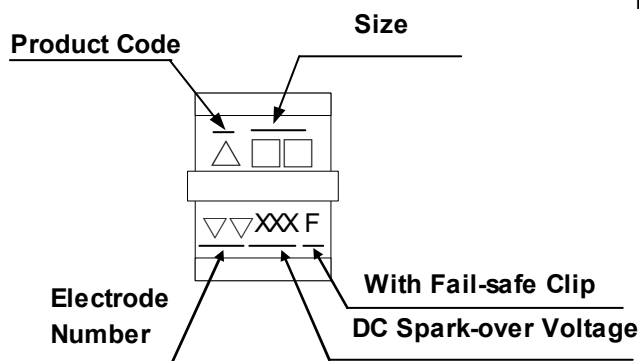
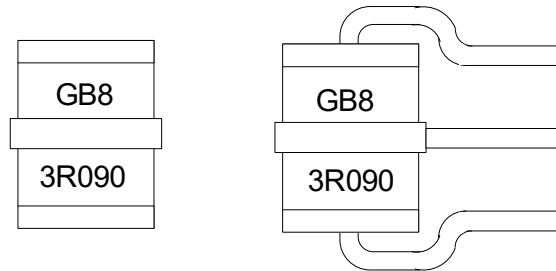

#### Example

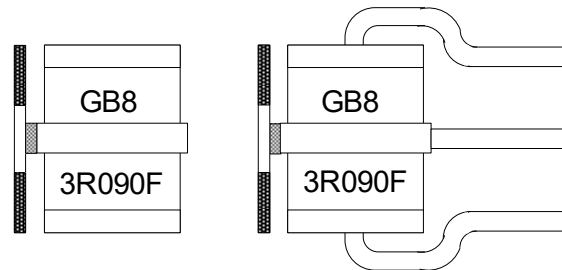

### ■ Packaging

#### ● Bulk :

Quantity: 100 pcs per PVC Box, and 500 pcs per Inner Box

Quantity (MPQ): 500pcs

### ■ Warehouse Storage Conditions of Products

#### ● Storage Conditions:

1. Storage Temperature:  $-10^{\circ}\text{C}\sim+40^{\circ}\text{C}$
2. Relative Humidity:  $\leq 75\% \text{RH}$
3. Keep away from corrosive atmosphere and sunlight.

#### ● Period of Storage: 1 year