

Gas Discharge Tube: G12D8A Series



2-Electrode $\Phi 11.8 \times T8$ mm Type

■ Features

1. RoHS & HF compliant
2. Rugged ceramic-metal construction
3. DC spark-over voltage: 230~800V
4. Follow current at 50/60Hz: 100A (For 470~800V)
5. Max continuous operating voltage at 50/60Hz: 255V (For 470~800V)
6. Agency recognition: UL
7. Operating temperature: $-40^{\circ}\text{C} \sim +105^{\circ}\text{C}$
Storage temperature: $-40^{\circ}\text{C} \sim +115^{\circ}\text{C}$

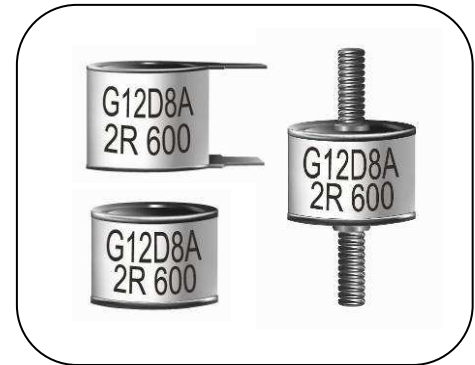

■ Recommended Applications

1. Power system
2. Industrial equipment
3. SPD module

■ Part Number Code

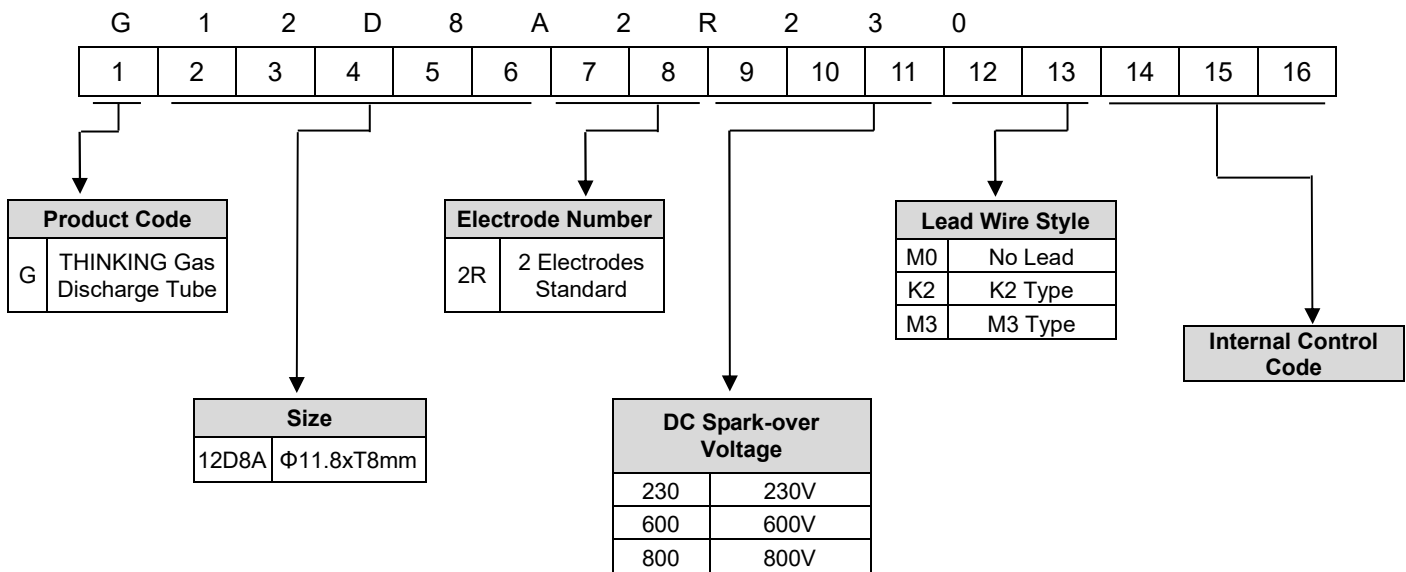

Gas Discharge Tube: G12D8A Series



2-Electrode $\Phi 11.8 \times T8$ mm Type

Characteristics

Part No.	DC Spark-over Voltage	Max. Impulse Breakdown Voltage	Max. Impulse Discharge Current (8/20 μ s)		Impulse Life (10/1000 μ s)	Normal Alternating Discharge Current	Max. Front-of-wave sparkover voltage	Follow Current	Max Continuous Operating Voltage	Minimum Insulation Resistance (G Ω)	Maximum Breakdown Time (ns)	Safety Approvals
	100V/S	1KV/ μ s	1 time	10 times	300A	50Hz, 1Sec	1.2/50us 6KV	50/60Hz	50/60Hz			
	(V)	(V)	(KA)		(times)	(A)	(V)	(A)	(V)			
G12D8A2R230□□	230 \pm 20%	700	40	20	300	40	1100	/	/	1	100	✓
G12D8A2R250□□	250 \pm 20%	700					1100	/	/			✓
G12D8A2R300□□	300 \pm 20%	800					1100	/	/			✓
G12D8A2R350□□	350 \pm 20%	800					1100	/	/			✓
G12D8A2R420□□	420 \pm 20%	800					1200	/	/			✓
G12D8A2R470□□	470 \pm 20%	1000					1300	100	220			✓
G12D8A2R500□□	500 \pm 20%	1000					1300	100	255			✓
G12D8A2R600□□	600 \pm 20%	1200					1400	100	255			✓
G12D8A2R700□□	700 \pm 20%	1300					1500	100	255			✓
G12D8A2R800□□	800 \pm 20%	1400					1500	100	255			✓

Note 1: The □□ is the style of lead wire.

Note 2: UL 1449 4th File No: E314979.

Note 3: Insulation resistance test conditions:

DC Spark-over Voltage	DC Measuring Voltage
70-150V	50V
151-400V	100V
401-800V	250V

Dimensions

(Unit: mm)

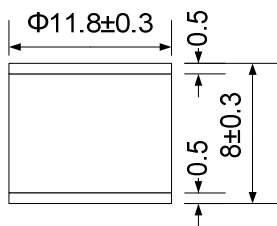

Figure 1

M0: No Lead

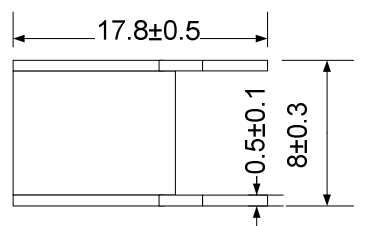

Figure 2

K2: K2 Type

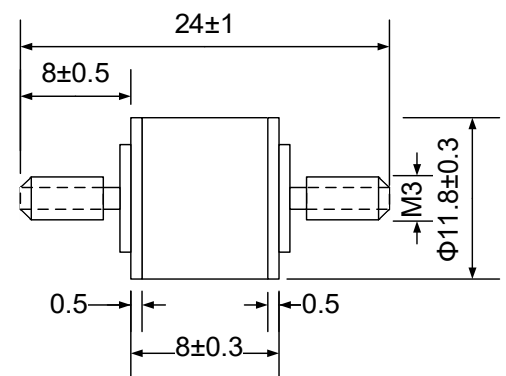

Figure 3

M3: M3 Type

Gas Discharge Tube: G12D8A Series



2-Electrode $\Phi 11.8 \times T8$ mm Type

■ Marking

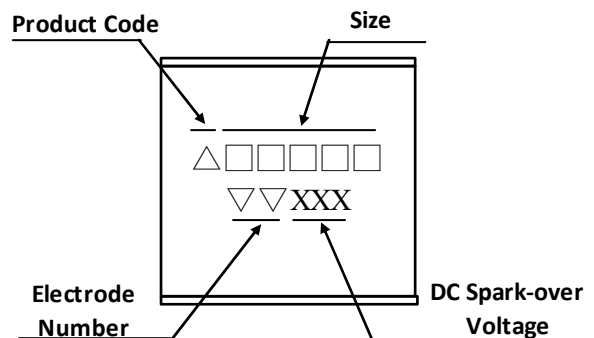

Example

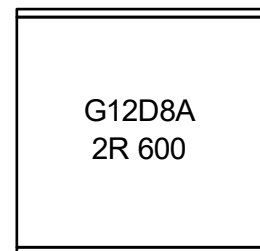

■ Packaging

- Bulk

■ Warehouse Storage Conditions of Products

- Storage Conditions:
 1. Storage Temperature: $-10^{\circ}\text{C} \sim +40^{\circ}\text{C}$
 2. Relative Humidity: $\leq 75\% \text{RH}$
 3. Keep away from corrosive atmosphere and sunlight.
- Period of Storage: 1 year