

NTC Thermistor: SCH Series

High Power Type NTC Thermistor for Inrush Current Limiting



■ Features

1. RoHS & Halogen Free (HF) compliant
2. Body size: $\Phi 20\text{mm}$, $\Phi 25\text{mm}$, $\Phi 30\text{mm}$
3. Radial lead resin coated
4. Higher steady state current
5. 15% reduction of installation space when comparing with similar components

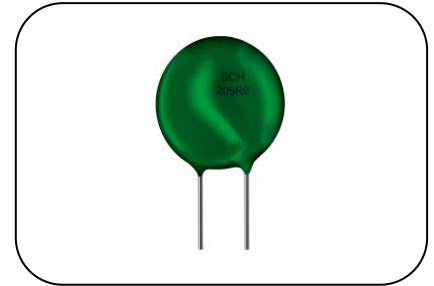

■ Recommended Applications

1. High power switching mode power supply (SMPS), uninterruptible power supply (UPS), power conversion equipment
2. Charger and charging station of electric vehicle
3. Motor drive system, high power plasma welding machine, cutting machine, high power lighting application
4. Magnetic resonance imaging (MRI) equipment, professional high power audio receiver, high power toroidal transformer, high capacity power inverter
5. Industrial robot driven by high voltage power supply, smart low-voltage power distribution unit

■ Part Number Code

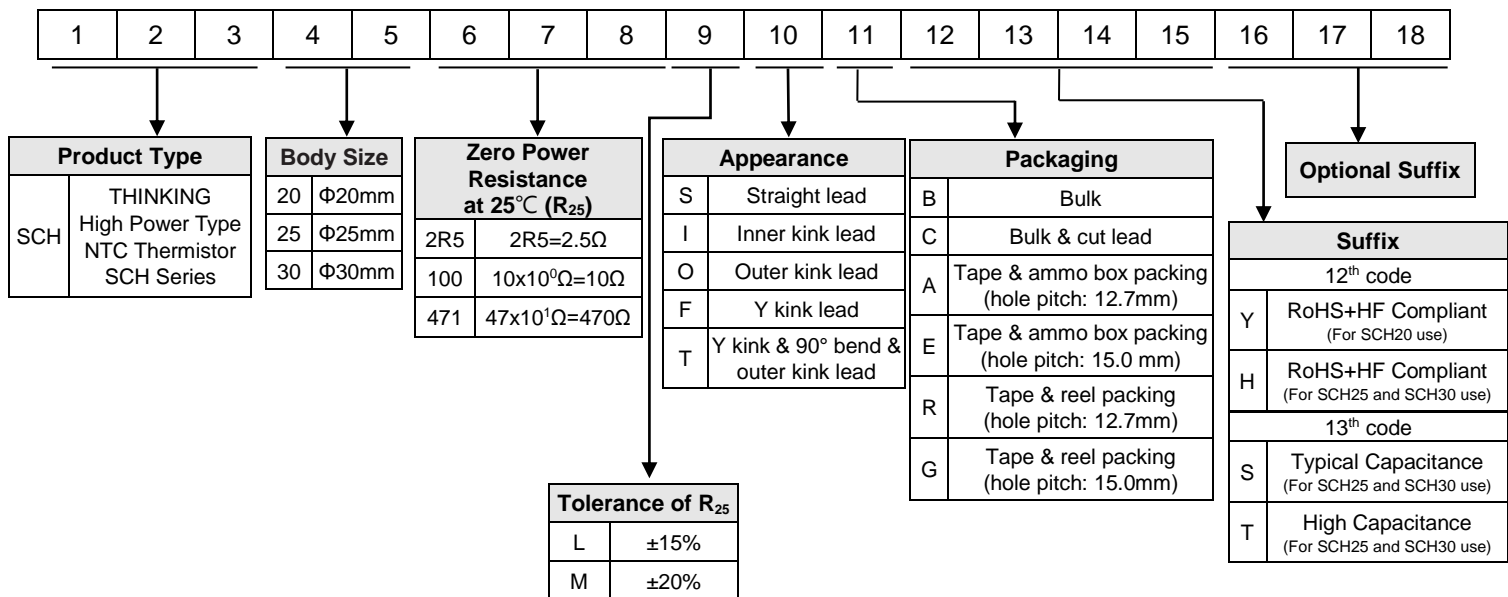

NTC Thermistor: SCH Series

High Power Type NTC Thermistor for Inrush Current Limiting



Structure and Dimensions

S Type (Straight lead)

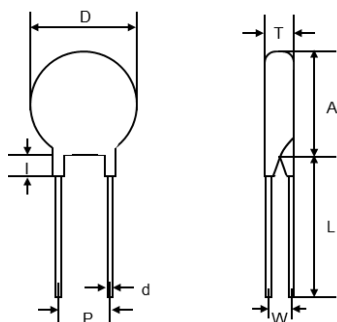

(Unit: mm)

Body Size	D	P	d	l max.	A max.	L min.	T	W
Φ20	18~21.5	7.5±0.5	1±0.02	3	21.5	26	3.5~6	3.1±0.5
Φ25-S	23~29	7.5±1	1±0.02	3	29	22	5±1	3.3±0.5
Φ25-T	23~29	7.5±1	1±0.02	3	29	22	6±1	3.6±0.5
Φ30-S	30~36	7.5±1	1±0.02	3	36	22	5±1	3.3±0.5
Φ30-T	30~36	7.5±1	1±0.02	3	36	22	6±1	3.6±0.5

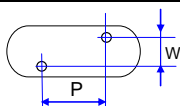

P: horizontal projection distance of lead wires center

SC Type (Straight cut lead)

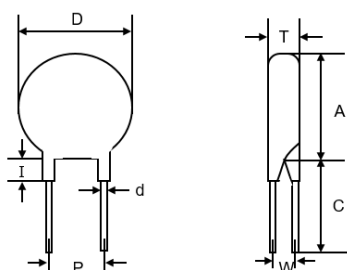

(Unit: mm)

Body Size	D	P	d	l max.	A max.	C nor.	T	W
Φ20	18~21.5	7.5±0.5	1±0.02	3	21.5	□±1	3.5~6	3.1±0.5
Φ25-S	23~29	7.5±1	1±0.02	3	29	□±1	5±1	3.3±0.5
Φ25-T	23~29	7.5±1	1±0.02	3	29	□±1	6±1	3.6±0.5
Φ30-S	30~36	7.5±1	1±0.02	3	36	□±1	5±1	3.3±0.5
Φ30-T	30~36	7.5±1	1±0.02	3	36	□±1	6±1	3.6±0.5

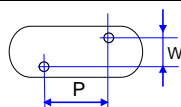

P: horizontal projection distance of lead wires center

I Type (Inner kink lead)

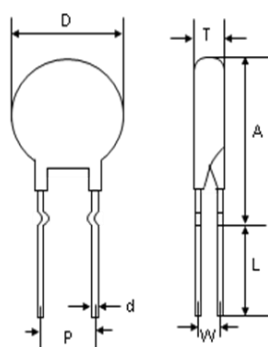

(Unit: mm)

Body Size	D	P	d	A max.	L min.	T	W
Φ20	18~21.5	7.5±0.5	1±0.02	28	24	3.5~6	3.1±0.5
Φ25-S	23~29	7.5±1	1±0.02	35	22	5±1	3.3±0.5
Φ25-T	23~29	7.5±1	1±0.02	35	22	6±1	3.6±0.5
Φ30-S	30~36	7.5±1	1±0.02	42	22	5±1	3.3±0.5
Φ30-T	30~36	7.5±1	1±0.02	42	22	6±1	3.6±0.5

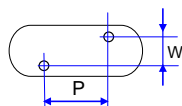

P: horizontal projection distance of lead wires center

IC Type (Inner kink cut lead)

(Unit: mm)

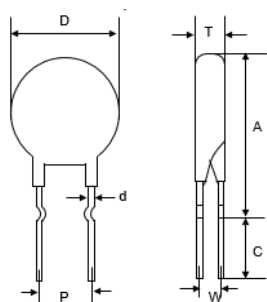

Body Size	D	P	d	A max.	C nor.	T	W
Φ20	18~21.5	7.5±0.5	1±0.02	28	□±1	3.5~6	3.1±0.5
Φ25-S	23~29	7.5±1	1±0.02	35	□±1	5±1	3.3±0.5
Φ25-T	23~29	7.5±1	1±0.02	35	□±1	6±1	3.6±0.5
Φ30-S	30~36	7.5±1	1±0.02	42	□±1	5±1	3.3±0.5
Φ30-T	30~36	7.5±1	1±0.02	42	□±1	6±1	3.6±0.5

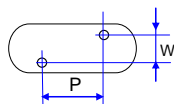

P: horizontal projection distance of lead wires center

NTC Thermistor: SCH Series

High Power Type NTC Thermistor for Inrush Current Limiting



O Type (Outer kink lead)

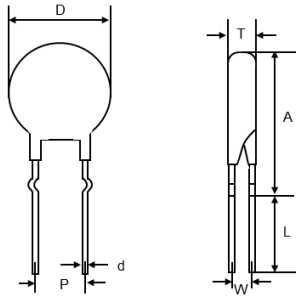

(Unit: mm)

Body Size	D	P	d	A max.	L min.	T	W
Φ20	18~21.5	7.5±0.5	1±0.02	30	24	3.5~6	3.1±0.5
Φ25-S	23~29	7.5±1	1±0.02	35	22	5±1	3.3±0.5
Φ25-T	23~29	7.5±1	1±0.02	35	22	6±1	3.6±0.5
Φ30-S	30~36	7.5±1	1±0.02	42	22	5±1	3.3±0.5
Φ30-T	30~36	7.5±1	1±0.02	42	22	6±1	3.6±0.5

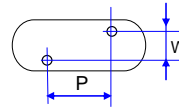

P: horizontal projection distance of lead wires center

OC Type (Outer kink lead)

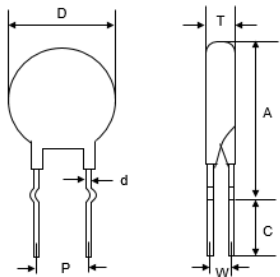

(Unit: mm)

Body Size	D	P	d	A max.	C nor.	T	W
Φ20	18~21.5	7.5±0.5	1±0.02	30	□±1	3.5~6	3.1±0.5
Φ25-S	23~29	7.5±1	1±0.02	35	□±1	5±1	3.3±0.5
Φ25-T	23~29	7.5±1	1±0.02	35	□±1	6±1	3.6±0.5
Φ30-S	30~36	7.5±1	1±0.02	42	□±1	5±1	3.3±0.5
Φ30-T	30~36	7.5±1	1±0.02	42	□±1	6±1	3.6±0.5

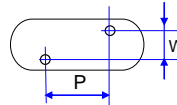

P: horizontal projection distance of lead wires center

F Type (Y kink lead)

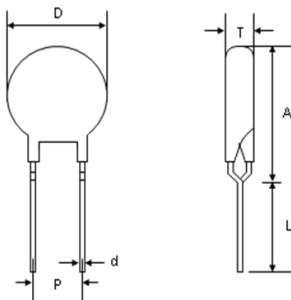

(Unit: mm)

Body Size	D	P	d	A max.	L min.	T
Φ20	18~21.5	7.5±0.5	1±0.02	24.5	25	3.5~6
Φ25-S	23~29	7.5±1	1±0.02	35	22	5±1
Φ25-T	23~29	7.5±1	1±0.02	35	22	6±1
Φ30-S	30~36	7.5±1	1±0.02	42	22	5±1
Φ30-T	30~36	7.5±1	1±0.02	42	22	6±1

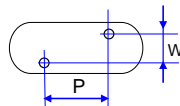

P: horizontal projection distance of lead wires center

FC Type (Y kink cut lead)

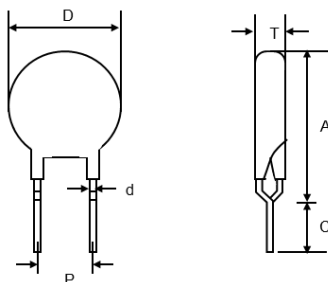

(Unit: mm)

Body Size	D	P	d	A max.	C nor.	T
Φ20	18~21.5	7.5±0.5	1±0.02	24.5	□±1	3.5~6
Φ25-S	23~29	7.5±1	1±0.02	35	□±1	5±1
Φ25-T	23~29	7.5±1	1±0.02	35	□±1	6±1
Φ30-S	30~36	7.5±1	1±0.02	42	□±1	5±1
Φ30-T	30~36	7.5±1	1±0.02	42	□±1	6±1

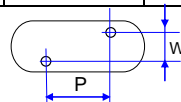

P: horizontal projection distance of lead wires center

NTC Thermistor: SCH Series

High Power Type NTC Thermistor for Inrush Current Limiting



T Type (Y kink and 90° bend and outer kink lead)

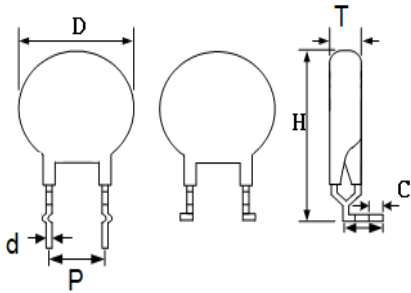

(Unit: mm)

Body Size	D	P	d	T	Hmax	C
Φ20	18~21.5	7.5±0.5	1±0.02	3.5~6	26	□±0.5

T Type (Y kink and 90° bend)

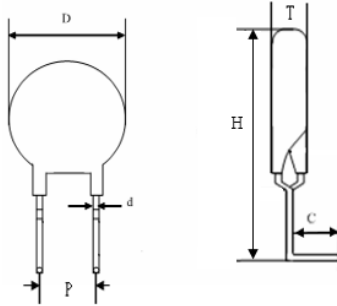

(Unit: mm)

Body Size	D	P	d	Hmax	C nor.	T
Φ20	18~21.5	7.5±0.5	1±0.02	28.5	□±0.5	3.5~6

■ Marking

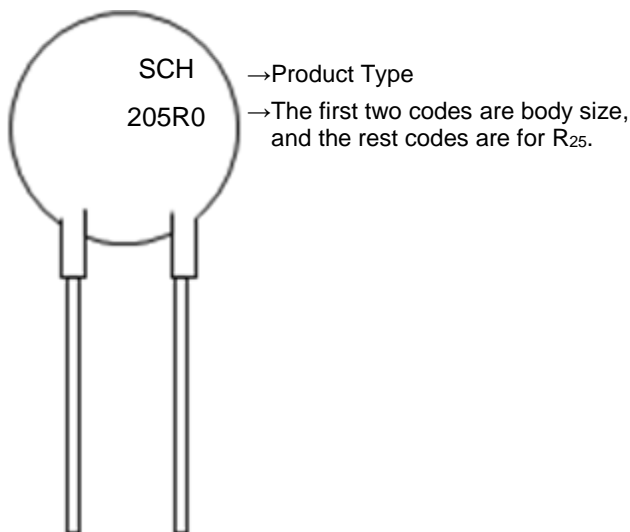

→Product Type
→The first two codes are body size, and the rest codes are for R₂₅.

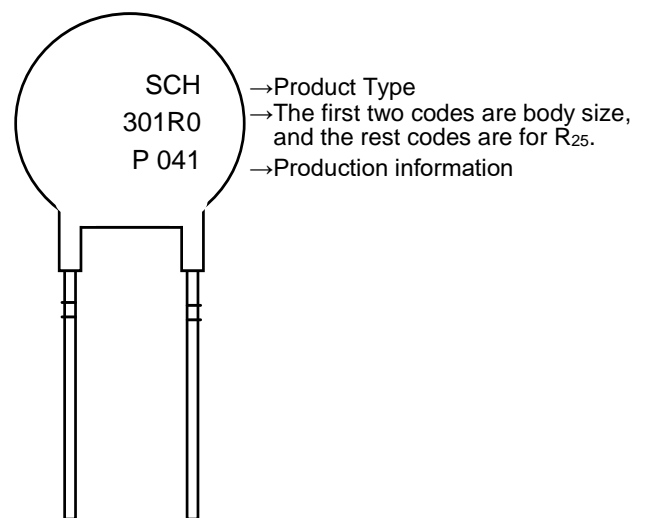

→Product Type
→The first two codes are body size, and the rest codes are for R₂₅.
→Production information

NTC Thermistor: SCH Series

High Power Type NTC Thermistor for Inrush Current Limiting



■ Electrical Characteristics

Part No.	Zero Power Resistance at 25°C		Max. Current at 65°C	Residual Resistance at 25°C I _{max}	B _{25/50} Value		Recommended Capacitance @240Vac	Max. Power Rating at 25°C	Dissipation Factor	Thermal Time Constant
	R ₂₅ (Ω)	(±%)	I _{max} (A)	R _{I_{max}} (Ω)	(K)	(±%)	C _{th} (μF)	P _{max} (W)	δ(mW/°C)	τ (Sec.)
SCH200R7	0.7	15	18	0.018	2300	7	1200	5.8	Around 28	Around 113
		20								
SCH201R0	1	15	16	0.023	2500					
		20								
SCH201R5	1.5	15	13	0.035	2600					
		20								
SCH202R0	2	15	12	0.042	2750					
		20								
SCH202R5	2.5	15	11	0.050	2750					
		20								
SCH203R0	3	15	11	0.052	2800					
		20								
SCH204R0	4	15	9.5	0.067	3000					
		20								
SCH204R7	4.7	15	9.5	0.074	3000					
		20								
SCH205R0	5	15	9.5	0.076	3000					
		20								
SCH206R0	6	15	9	0.083	3050					
		20								
SCH206R8	6.8	15	8.5	0.093	3100					
		20								
SCH207R0	7	15	8.5	0.095	3100					
		20								
SCH208R0	8	15	8	0.101	3150					
		20								
SCH20100	10	15	7.5	0.126	3200					
		20								
SCH20120	12	15	7.5	0.123	3200					
		20								
SCH20130	13	15	7.5	0.125	3250					
		20								
SCH20150	15	15	7	0.145	3250					
		20								
SCH20160	16	15	6.5	0.158	3300					
		20								
SCH20180	18	15	6	0.159	3350					
		20								
SCH20200	20	15	6	0.185	3350					
		20								
SCH20470	47	15	4.5	0.336	3550					
		20								
SCH20550	55	15	4	0.409	3550					
		20								
SCH20121	120	15	3	0.697	3550					
		20								

NTC Thermistor: SCH Series

High Power Type NTC Thermistor for Inrush Current Limiting



■ Electrical Characteristics

Part No	Zero Power Resistance at 25°C		Max. Current at 65°C	Residual Resistance at 25°C I _{max}	B _{25/50} Value		Recommended Capacitance @240Vac	Max. Power Rating at 25°C	Dissipation Factor	Thermal Time Constant																																													
	R ₂₅ (Ω)	(±%)	I _{max} (A)	R _{I_{max}} (Ω)	(K)	(±%)	C _{th} (μF)	P _{max} (W)	δ (mW/°C)	τ (Sec.)																																													
SCH251R0-S	1	15	22.5	0.019	2600	7	2200	9.6	Around 30	Around 130																																													
		20																																																					
SCH251R5-S	1.5	15	21.5	0.022	2600						7	2200	10.2	Around 30	Around 130																																								
		20																																																					
SCH252R0-S	2	15	21	0.024	2800											7	2200	10.6	Around 30	Around 130																																			
		20																																																					
SCH252R5-S	2.5	15	19.5	0.027	2800																7	2200	10.3	Around 30	Around 130																														
		20																																																					
SCH253R0-S	3	15	18	0.030	2900																					7	2200	9.7	Around 30	Around 130																									
		20																																																					
SCH254R0-S	4	15	17	0.035	3000																										7	2200	10.1	Around 30	Around 130																				
		20																																																					
SCH254R7-S	4.7	15	16.5	0.037	3100																															7	2200	10.1	Around 30	Around 130															
		20																																																					
SCH255R0-S	5	15	16	0.040	3100																																				7	2200	10.2	Around 30	Around 130										
		20																																																					
SCH256R8-S	6.8	15	14.5	0.054	3150																																									7	2200	11.4	Around 30	Around 130					
		20																																																					
SCH257R0-S	7	15	14	0.055	3150																																														7	2200	10.8	Around 30	Around 130
		20																																																					
SCH258R0-S	8	15	13	0.060	3200	7	2200	10.1	Around 30	Around 130																																													
		20																																																					
SCH25100-S	10	15	12	0.063	3300						7	2200	9.1	Around 30	Around 130																																								
		20																																																					
SCH25120-S	12	15	11	0.066	3300											7	2200	8.0	Around 30	Around 130																																			
		20																																																					
SCH25150-S	15	15	9	0.108	3350																7	2200	8.7	Around 30	Around 130																														
		20																																																					
SCH25180-S	18	15	8.5	0.115	3450																					7	2200	8.3	Around 30	Around 130																									
		20																																																					
SCH25200-S	20	15	8	0.139	3500																										7	2200	8.9	Around 30	Around 130																				
		20																																																					
SCH25121-S	120	15	5	0.377	4000																															7	2200	9.4	Around 30	Around 130															
		20																																																					

NTC Thermistor: SCH Series

High Power Type NTC Thermistor for Inrush Current Limiting



■ Electrical Characteristics

Part No	Zero Power Resistance at 25°C		Max. Current at 65°C	Residual Resistance at 25°C I _{max}	B _{25/50} Value		Recommended Capacitance @240Vac	Max. Power Rating at 25°C	Dissipation Factor	Thermal Time Constant
	R ₂₅ (Ω)	(±%)	I _{max} (A)	R _{I_{max}} (Ω)	(K)	(±%)	C _{th} (μF)	P _{max} (W)	δ(mW/°C)	τ (Sec.)
SCH251R0-T	1	15	22.5	0.019	2600	7	4200	9.6	Around 30	Around 130
		20								
SCH251R5-T	1.5	15	21.5	0.022	2600					
		20								
SCH252R0-T	2	15	21	0.024	2800					
		20								
SCH252R5-T	2.5	15	19.5	0.027	2800					
		20								
SCH253R0-T	3	15	18	0.030	2900					
		20								
SCH254R0-T	4	15	17	0.035	3000					
		20								
SCH254R7-T	4.7	15	16.5	0.037	3100					
		20								
SCH255R0-T	5	15	16	0.040	3100					
		20								
SCH256R8-T	6.8	15	14.5	0.054	3150					
		20								
SCH257R0-T	7	15	14	0.055	3150					
		20								
SCH258R0-T	8	15	13	0.060	3200					
		20								
SCH25100-T	10	15	12	0.063	3300					
		20								
SCH25120-T	12	15	11	0.066	3300					
		20								
SCH25150-T	15	15	9	0.108	3350					
		20								
SCH25180-T	18	15	8.5	0.115	3450					
		20								
SCH25200-T	20	15	8	0.139	3500					
		20								
SCH25121-T	120	15	5	0.377	4000					
		20								

NTC Thermistor: SCH Series

High Power Type NTC Thermistor for Inrush Current Limiting



■ Electrical Characteristics

Part No	Zero Power Resistance at 25°C		Max. Current at 65°C	Residual Resistance at 25°C I _{max}	B _{25/50} Value		Recommended Capacitance @240Vac	Max. Power Rating at 25°C	Dissipation Factor	Thermal Time Constant
	R ₂₅ (Ω)	(±%)	I _{max} (A)	R _{I_{max}} (Ω)	(K)	(±%)	C _{th} (μF)	P _{max} (W)	δ(mW/°C)	τ (Sec.)
SCH300R5-S	0.5	15	38	0.010	2600	7	3000	14.4	Around 40	Around 190
		20								
SCH301R0-S	1	15	34	0.012	2600					
		20								
SCH301R5-S	1.5	15	30	0.014	2600					
		20								
SCH302R0-S	2	15	27	0.017	2800					
		20								
SCH302R5-S	2.5	15	24	0.021	2800					
		20								
SCH303R0-S	3	15	24	0.023	3000					
		20								
SCH304R0-S	4	15	21	0.029	3000					
		20								
SCH304R7-S	4.7	15	20	0.032	3100					
		20								
SCH305R0-S	5	15	19.5	0.033	3150					
		20								
SCH306R0-S	6	15	18	0.037	3200					
		20								
SCH306R8-S	6.8	15	17	0.040	3250					
		20								
SCH307R0-S	7	15	17	0.041	3250					
		20								
SCH308R0-S	8	15	16.5	0.045	3250					
		20								
SCH30100-S	10	15	16	0.052	3300					
		20								
SCH30120-S	12	15	14	0.064	3450					
		20								
SCH30150-S	15	15	14	0.073	3500					
		20								
SCH30180-S	18	15	12	0.092	3500					
		20								
SCH30200-S	20	15	10	0.104	3550					
		20								

NTC Thermistor: SCH Series

High Power Type NTC Thermistor for Inrush Current Limiting



■ Electrical Characteristics

Part No	Zero Power Resistance at 25°C		Max. Current at 65°C	Residual Resistance at 25°C I _{max}	B _{25/50} Value		Recommended Capacitance @240Vac	Max. Power Rating at 25°C	Dissipation Factor	Thermal Time Constant
	R ₂₅ (Ω)	(±%)	I _{max} (A)	R _{I_{max}} (Ω)	(K)	(±%)	C _{th} (μF)	P _{max} (W)	δ(mW/°C)	τ (Sec.)
SCH300R5-T	0.5	15	38	0.010	2600	7	5200	14.4	Around 40	Around 190
		20								
SCH301R0-T	1	15	34	0.012	2600					
		20								
SCH301R5-T	1.5	15	30	0.014	2600					
		20								
SCH302R0-T	2	15	27	0.017	2800					
		20								
SCH302R5-T	2.5	15	24	0.021	2800					
		20								
SCH303R0-T	3	15	24	0.023	3000					
		20								
SCH304R0-T	4	15	21	0.029	3000					
		20								
SCH304R7-T	4.7	15	20	0.032	3100					
		20								
SCH305R0-T	5	15	19.5	0.033	3150					
		20								
SCH306R0-T	6	15	18	0.037	3200					
		20								
SCH306R8-T	6.8	15	17	0.040	3250					
		20								
SCH307R0-T	7	15	17	0.041	3250					
		20								
SCH308R0-T	8	15	16.5	0.045	3250					
		20								
SCH30100-T	10	15	16	0.052	3300					
		20								
SCH30120-T	12	15	14	0.064	3450					
		20								
SCH30150-T	15	15	14	0.073	3500					
		20								
SCH30180-T	18	15	12	0.092	3500					
		20								
SCH30200-T	20	15	10	0.104	3550					
		20								

NTC Thermistor: SCH Series

High Power Type NTC Thermistor for Inrush Current Limiting



Max. Current Derating Curve

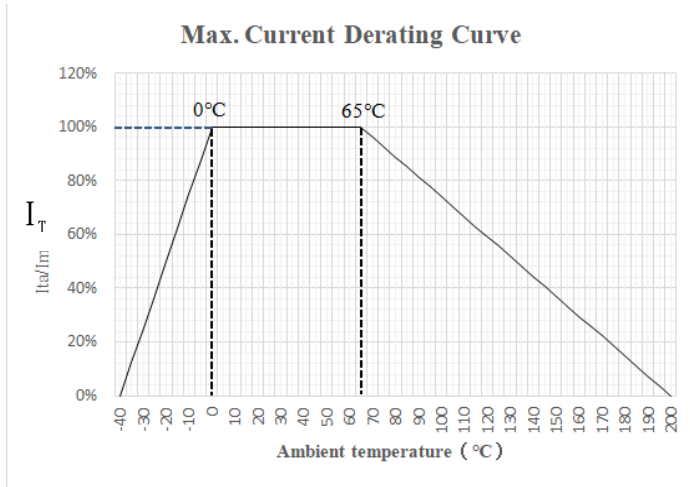

T_U : Maximum operating temperature ($^{\circ}\text{C}$)
 T_L : Minimum operating temperature ($^{\circ}\text{C}$)

For example:

● Ambient temperature (T_a) = 85°C
 Maximum operating temperature (T_U) = 200°C
 $I_{T_a} = [1 - (T_a - 65) / (T_U - 65)] \times I_{max} = 85.2\% I_{max}$

● Ambient temperature (T_a) = -10°C
 Minimum operating temperature (T_L) = -40°C
 $I_{T_a} = (1 - T_a / T_L) \times I_{max} = 75\% I_{max}$

R-T Characteristic Curves

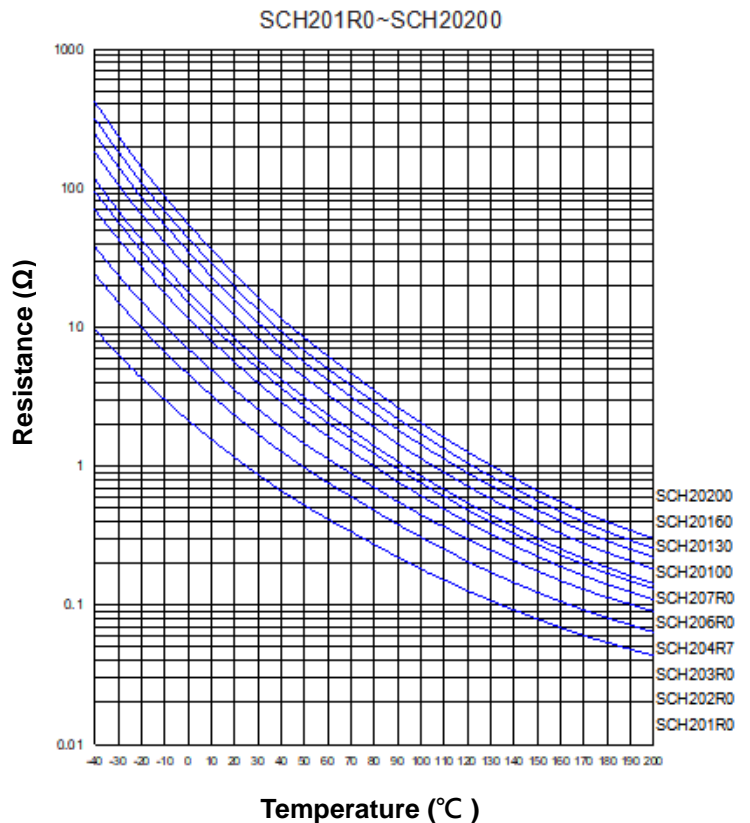
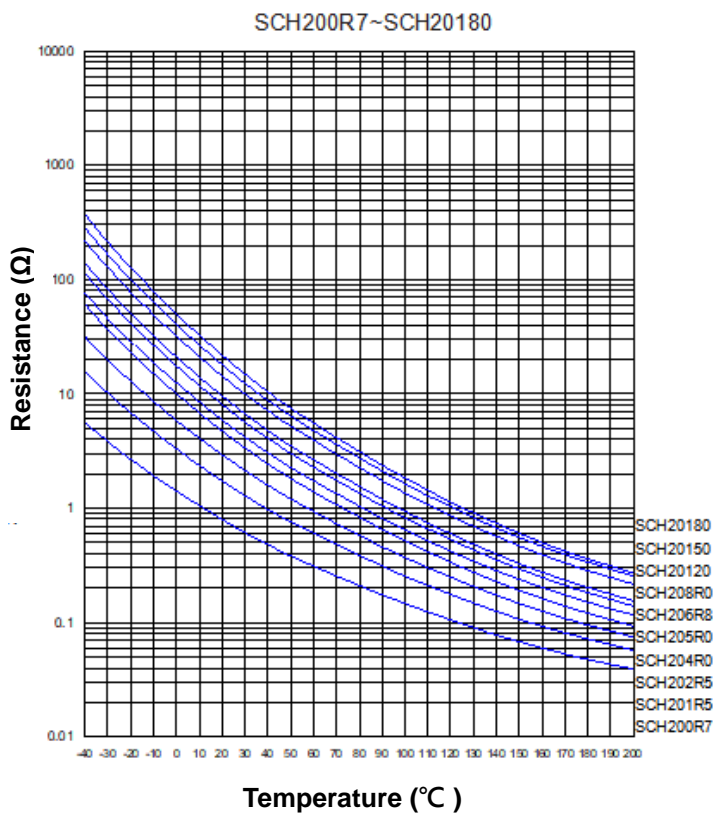

NTC Thermistor: SCH Series

High Power Type NTC Thermistor for Inrush Current Limiting



R-T Characteristic Curves

SCH20470-SCH20121

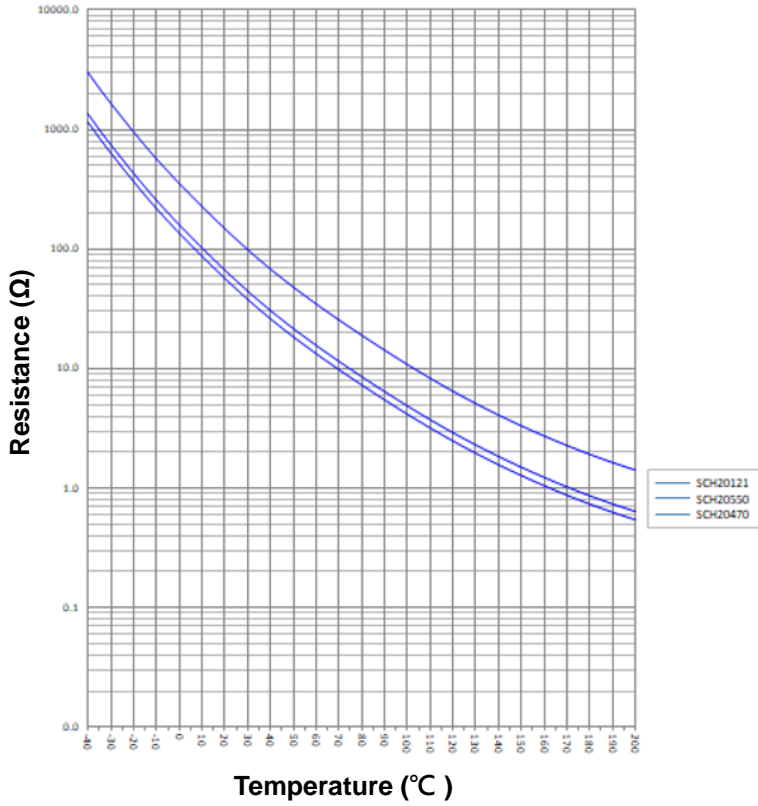

SCH251R0~SCH25180

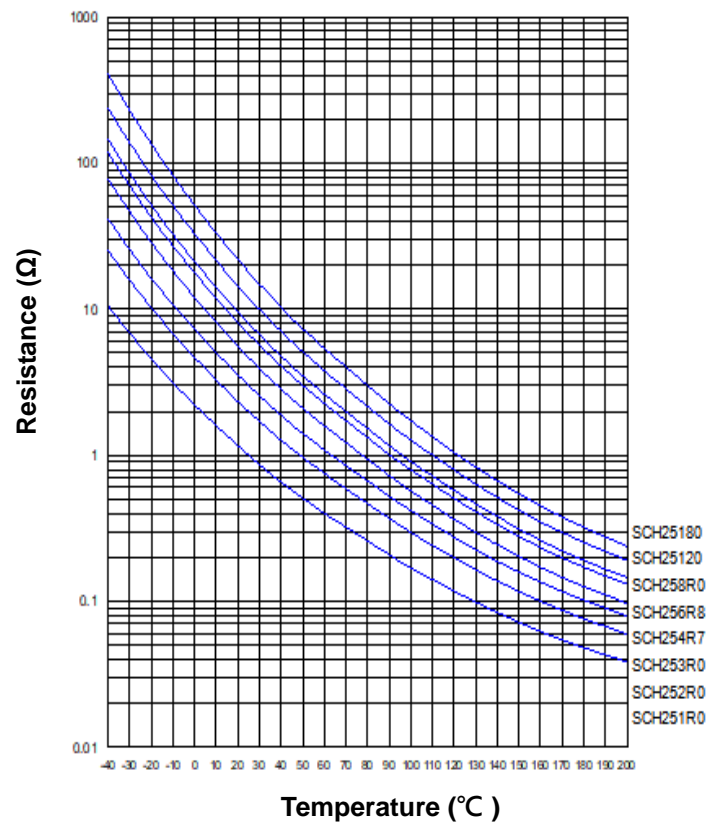

SCH251R5~SCH25200

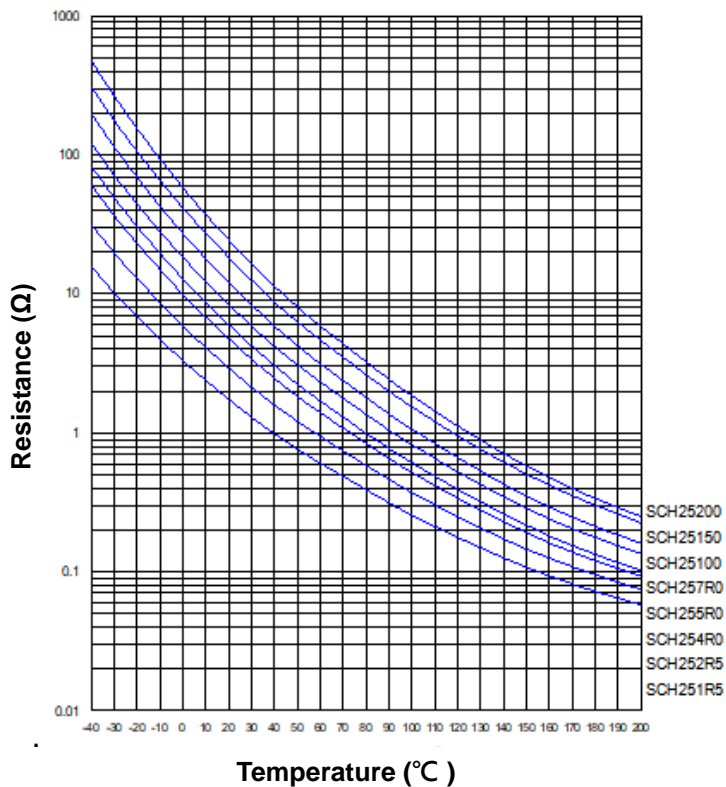

SCH301R0~SCH30180

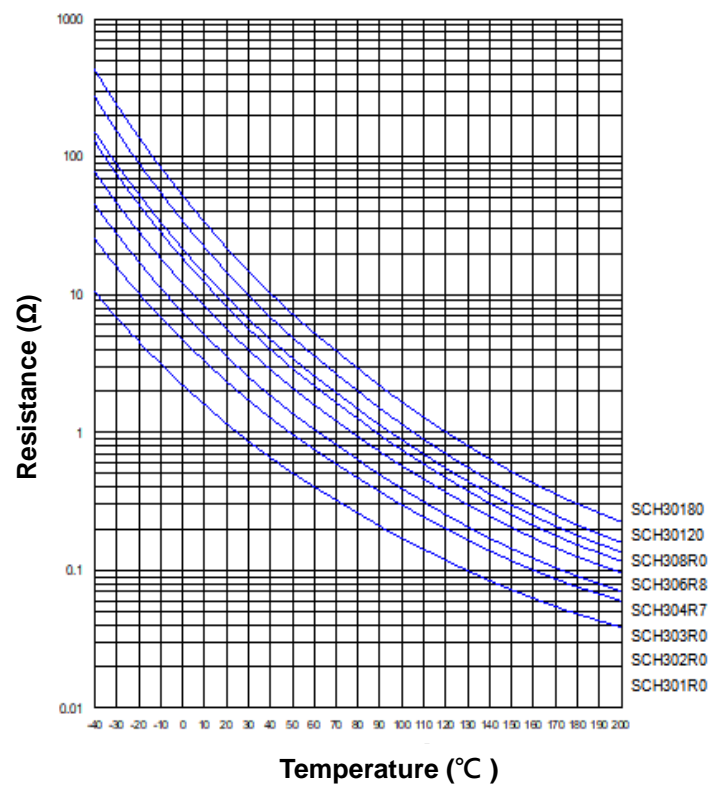

NTC Thermistor: SCH Series

High Power Type NTC Thermistor for Inrush Current Limiting



■ V-I Characteristic Curves (representative)

SCH200R7~SCH20550

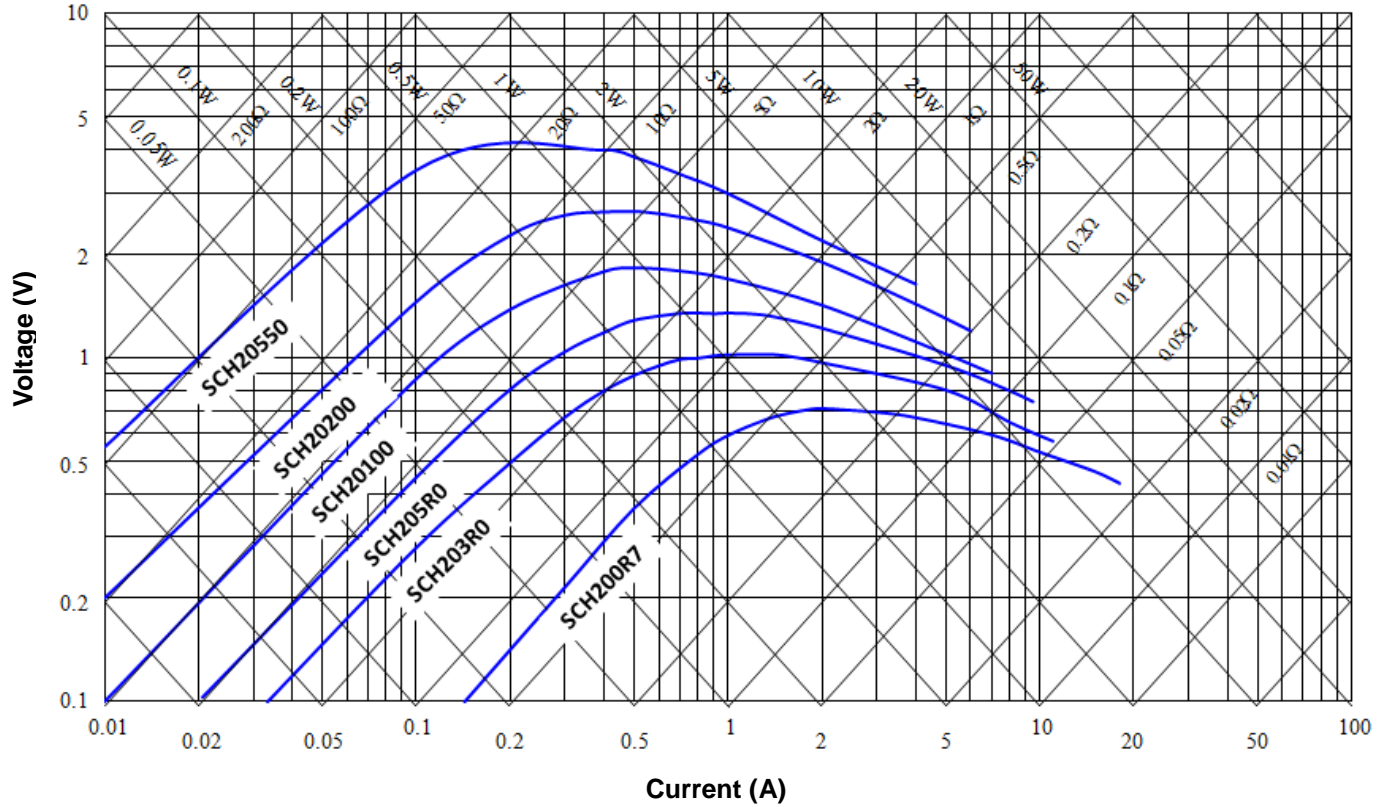

SCH251R0~SCH25121

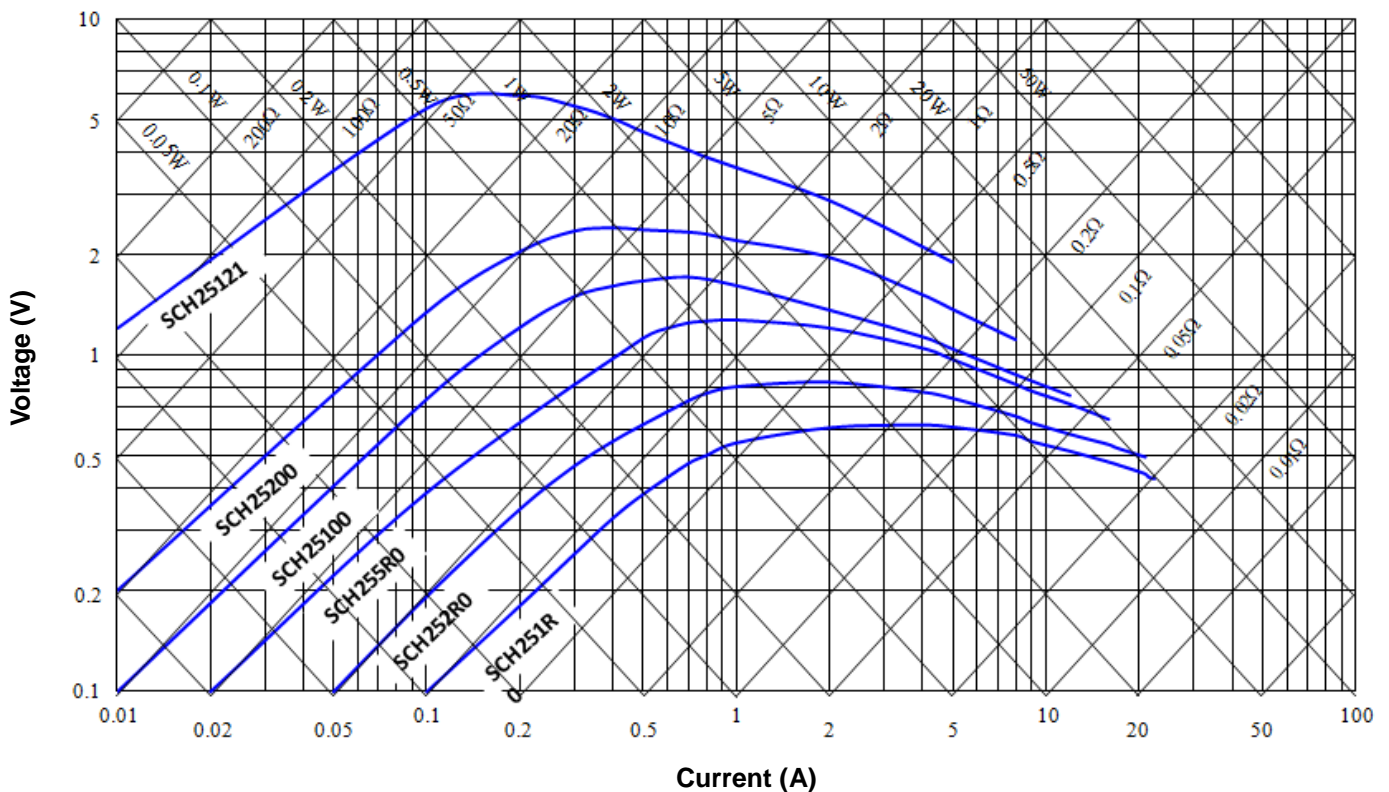

NTC Thermistor: SCH Series

High Power Type NTC Thermistor for Inrush Current Limiting



■ V-I Characteristic Curves (representative)

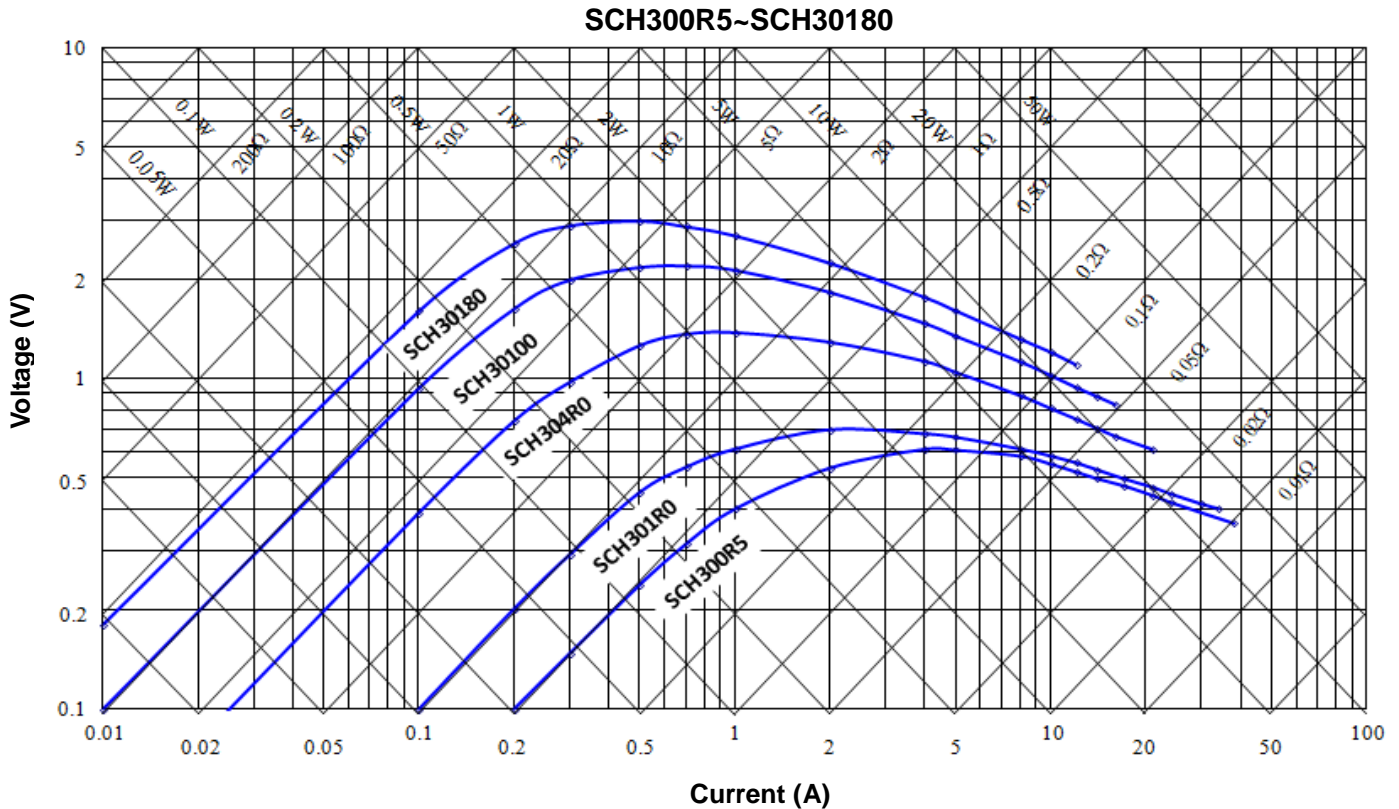

■ Soldering Recommendation

● Wave Soldering Profile

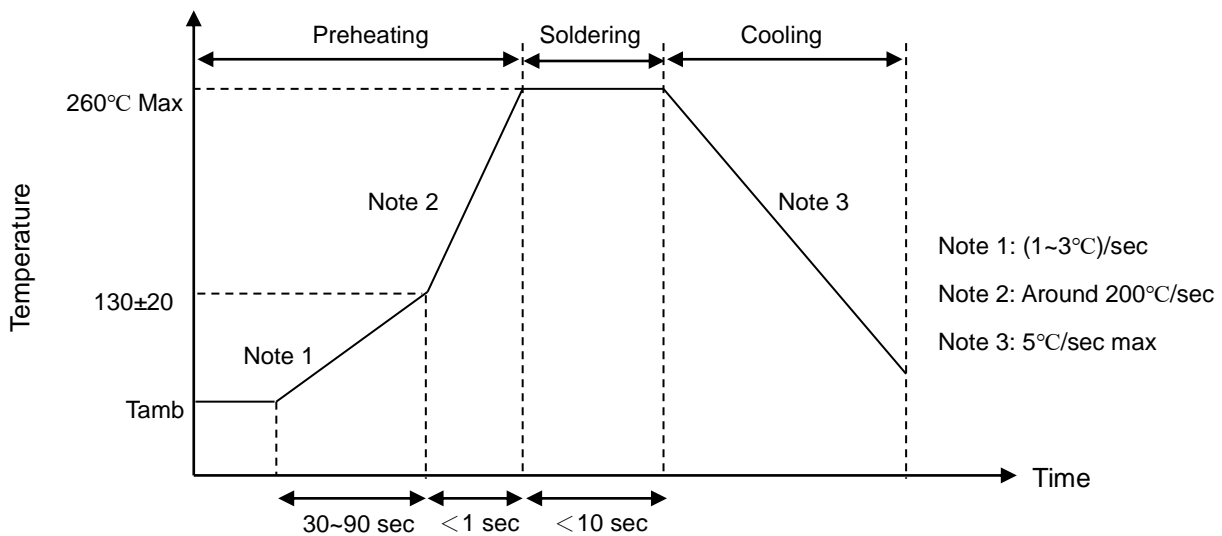

● Recommended Reworking Conditions with Soldering Iron

Item	Condition
Temperature of Soldering Iron-tip	360°C (max.)
Soldering Time	3 sec. (max.)
Distance from Thermistor	2 mm (min.)

NTC Thermistor: SCH Series

High Power Type NTC Thermistor for Inrush Current Limiting



■ Reliability

Item	Standard	Test conditions/Method	Specification															
Tensile Strength of Terminals	IEC 60068-2-21	2kg, 10 ± 1 sec	$ \Delta R_{25}/R_{25} \leq 10\%$															
Resistance to Soldering Heat	IEC 60068-2-20	260 ± 3°C, 10 ± 1 sec (Soaking Method)	$ \Delta R_{25}/R_{25} \leq 10\%$ No visible damage															
High Temperature Storage	IEC 60068-2-2	$T_U \pm 5^\circ\text{C}$, 1000 ± 24 hrs	$ \Delta R_{25}/R_{25} \leq 20\%$ No visible damage															
Damp Heat, Steady State	IEC 60068-2-78	40 ± 2°C, 90~95% RH, 1000 ± 24 hrs	$ \Delta R_{25}/R_{25} \leq 20\%$ No visible damage															
Rapid Change of Temperature	IEC 60068-2-14	<p>The conditions shown below shall be repeated 5 cycles.</p> <table border="1"> <thead> <tr> <th>Step</th> <th>Temperature (°C)</th> <th>Period (minutes)</th> </tr> </thead> <tbody> <tr> <td>1</td> <td>$T_L \pm 5$</td> <td>30 ± 3</td> </tr> <tr> <td>2</td> <td>Room temperature</td> <td>5 ± 3</td> </tr> <tr> <td>3</td> <td>$T_U \pm 5$</td> <td>30 ± 3</td> </tr> <tr> <td>4</td> <td>Room temperature</td> <td>5 ± 3</td> </tr> </tbody> </table>	Step	Temperature (°C)	Period (minutes)	1	$T_L \pm 5$	30 ± 3	2	Room temperature	5 ± 3	3	$T_U \pm 5$	30 ± 3	4	Room temperature	5 ± 3	$ \Delta R_{25}/R_{25} \leq 20\%$ No visible damage
Step	Temperature (°C)	Period (minutes)																
1	$T_L \pm 5$	30 ± 3																
2	Room temperature	5 ± 3																
3	$T_U \pm 5$	30 ± 3																
4	Room temperature	5 ± 3																
Max. Current (I _{max})	IEC 60539-1 4.26.1	25 ± 5°C, I _{max} ., 1000 ± 24 hrs	$ \Delta R_{25}/R_{25} \leq 20\%$ No visible damage															
Endurance (Maximum permissible capacitance)	IEC60539-1 5.25.6 Method 1	Ambient temperature: 25 ± 5 °C Capacitance = C _{test} , Number of cycles: 1000 Cooling time = 5τ.	$ \Delta R_{25}/R_{25} \leq 20\%$ No visible damage															

NTC Thermistor: SCH Series

High Power Type NTC Thermistor for Inrush Current Limiting



■ Packaging

- Taping Specification
- S Type (Straight lead)

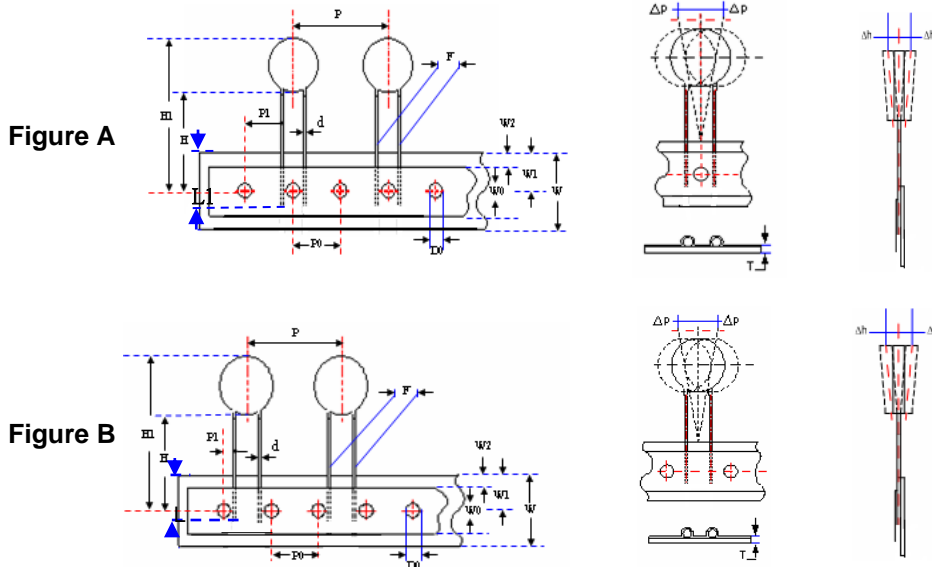

(Unit: mm)

Taping Dimension	Disc Size	P0	F	P	P1	H	H1	d	W0	W1	W2	W	ΔP	Δh	L1	D0	T	Figure
		±0.3	±0.5	±1	±0.7	+2/-0	Max.	±0.02	±1.5	+0.75/-0.5	Max.	+1/-0.5	Max.	Max.	Min	±0.2	±0.2	
P0:12.7	20	12.7	7.5	25.4	8.95	18	42	1.0	12	9	3	18	1	2	9	4	0.6	A
	20	12.7	10	25.4	7.70	18	42	1.0	12	9	3	18	1	2	9	4	0.6	A
P0:15.0	20	15.0	7.5	30	3.75	18	42	1.0	12	9	3	18	1	2	9	4	0.6	B
	20	15.0	10	30	10.0	18	42	1.0	12	9	3	18	1	2	9	4	0.6	A

I Type (Inner kink lead)

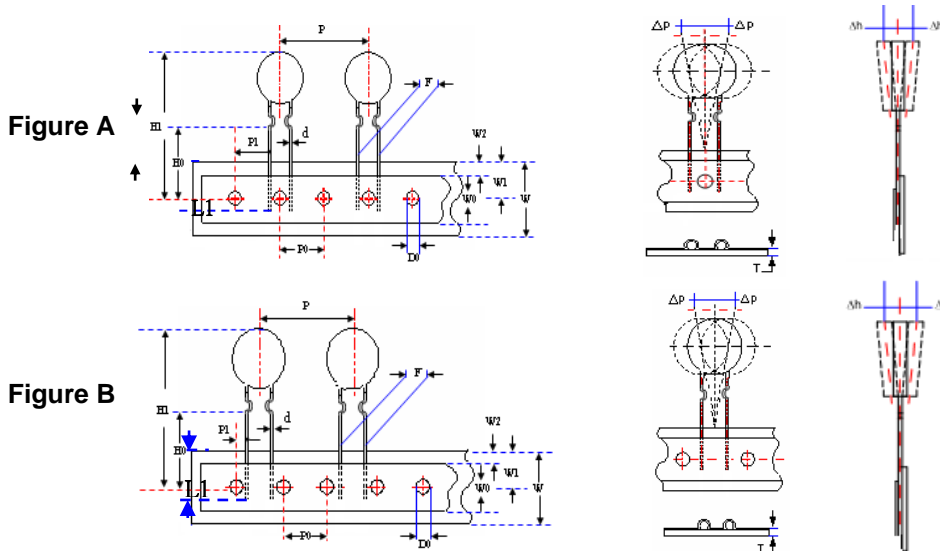

Taping Dimension	Disc Size	P0	F	P	P1	H0	H1	d	W0	W1	W2	W	ΔP	Δh	L1	D0	(Unit: mm)	Figure
		±0.3	±0.5	±1	±0.7	+2/-0	Max.	±0.02	±1.5	+0.75/-0.5	Max.	+1/-0.5	Max.	Max.	Min	±0.2	±0.2	
P0:12.7	20	12.7	7.5	25.4	8.95	16	44	1.0	12	9	3	18	1	2	9	4	0.6	A
	20	12.7	10	25.4	7.7	16	44	1.0	12	9	3	18	1	2	9	4	0.6	A
P0:15.0	20	15.0	7.5	30	3.75	16	44	1.0	12	9	3	18	1	2	9	4	0.6	B
	20	15.0	10	30	10	16	44	1.0	12	9	3	18	1	2	9	4	0.6	A

NTC Thermistor: SCH Series

High Power Type NTC Thermistor for Inrush Current Limiting



O Type (Outer kink lead)

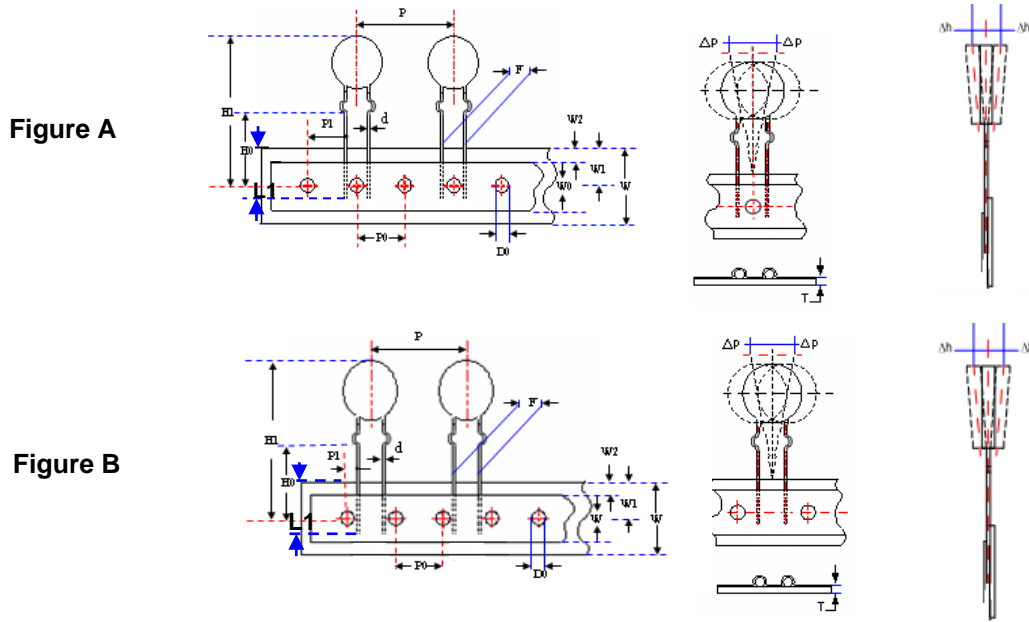

(Unit: mm)

Taping Dimension	Disc Size	P0	F	P	P1	H	H1	d	W0	W1	W2	W	ΔP	Δh	L1	D0	T	Figure
		±0.3	±0.5	±1	±0.7	+2/-0	Max.	±0.02	±1.5	+0.75 /-0.5	Max.	+1/ -0.5	Max.	Max.	Min	±0.2	±0.2	
P0:12.7	20	12.7	7.5	25.4	8.95	16	46	1.0	12	9	3	18	1	2	9	4	0.6	A
	20	12.7	10	25.4	7.7	16	44	1.0	12	9	3	18	1	2	9	4	0.6	A
P0:15.0	20	15.0	7.5	30	3.75	16	46	1.0	12	9	3	18	1	2	9	4	0.6	B
	20	15.0	10	30	10	16	44	1.0	12	9	3	18	1	2	9	4	0.6	A

F Type (Y kink lead)

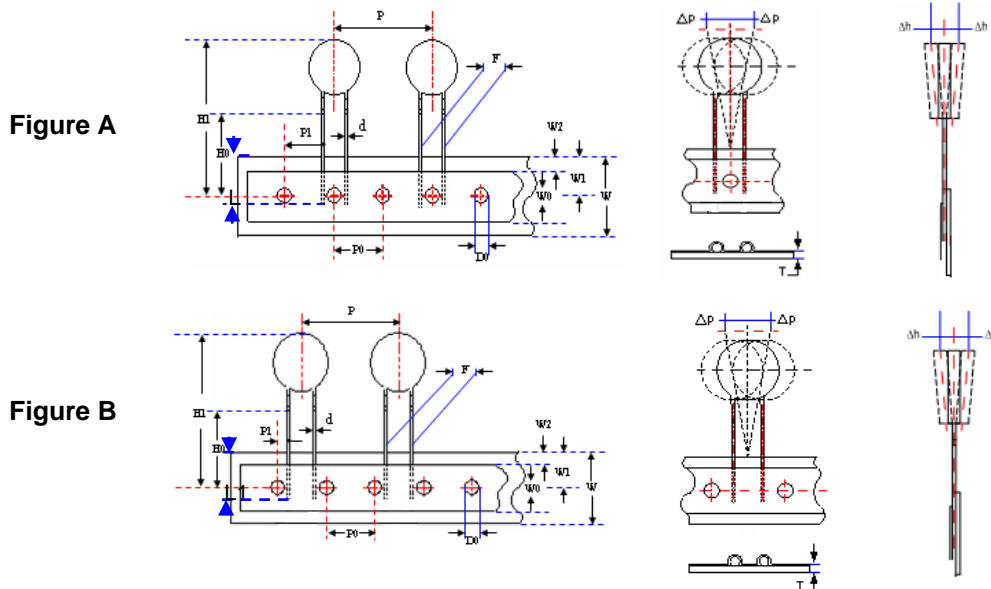

(Unit: mm)

Taping Dimension	Disc Size	P0	F	P	P1	H	H1	d	W0	W1	W2	W	ΔP	Δh	L1	D0	T	Figure
		±0.3	±0.5	±1	±0.7	+2/-0	Max.	±0.02	±1.5	+0.75 /-0.5	Max.	+1/ -0.5	Max.	Max.	Min	±0.2	±0.2	
P0:12.7	20	12.7	7.5	25.4	8.95	16	42	1	12	9	3	18	1	2	9	4	0.6	A
	20	12.7	10	25.4	7.70	16	42	1	12	9	3	18	1	2	9	4	0.6	A
P0:15.0	20	15.0	7.5	30	3.75	16	42	1	12	9	3	18	1	2	9	4	0.6	B
	20	15.0	10	30	10	16	42	1.0	12	9	3	18	1	2	9	4	0.6	A

NTC Thermistor: SCH Series

High Power Type NTC Thermistor for Inrush Current Limiting



Quantity

- **Bulk:** Packing of $\Phi 20$ products with 90° bend (cut lead products are included)

Size	Product quantity per bag	Bag quantity per box	Product quantity per box	Box quantity per carton	Product quantity per carton	Lead structure	Ammo box dimensions	Carton dimensions
	(pcs)	(bags)	(pcs)	(carton)	(pcs)		(LxWxH) (Unit: mm)	(LxWxH) (Unit: mm)
$\Phi 20$	50	4	200	8	1600	90° bend	160x160x65	350x350x140
	50	4	200	8	1600	Cut lead		

● Ammo Packing

1. Cardboard strips

Packing Method: 20 pcs/strip, 30 strips/box, 600pcs/box

Box Dimensions: 340x340x62mm

Dimension and packing method of carton

Box quantity per carton	Product quantity per carton (pcs/carton)	Carton dimensions (LxWxH) (Unit: mm)
2 boxes	1200 pcs	350x350x140

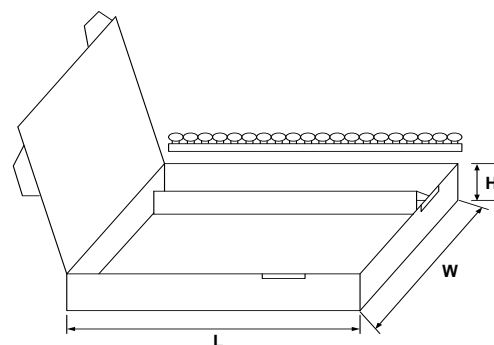

2. Ammo Box Tapping

Disc Size	Product quantity per box	Box dimensions	Carton dimensions	Box quantity of per carton
	(pcs)	(LxWxH) (Unit: mm)	(LxWxH) (Unit: mm)	(Box)
$\Phi 20$	400	345x275x55	350x310x290	5

3. Cardboard

Disc Size	Product quantity per cardboard	Cardboard dimensions	Product quantity per inner box	Inner box dimensions	Inner box quantity per outer box	Outer box dimensions
	(pcs)	(LxWxH) (Unit: mm)	(pcs)	(LxWxH) (Unit: mm)	(box)	(LxWxH) (Unit: mm)
$\Phi 25$	22	320x155x30	330	340x165x125	2	340x165x125
$\Phi 30$		320x155x35				

NTC Thermistor: SCH Series

High Power Type NTC Thermistor for Inrush Current Limiting



● Reel Packing

Dimensions of Cardboard Reels			
Disc Size	D	D1	W
Φ20	340±10mm	31±1mm	55±1mm
Note: Reels for products with customized height are available			

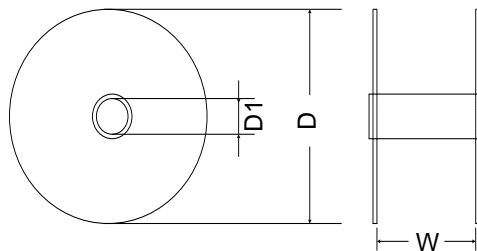

Disc Size	Product quantity per reel	Box dimensions	Carton dimensions	Reel quantity per carton (Reel and outer box)
	(pcs)	(LxWxH) (Unit: mm)	(LxWxH) (Unit: mm)	
Φ20	400	No inner box	350x350x290	4

■ Warehouse Storage Conditions of Products

- Storage Conditions:
 1. Storage Temperature: -10°C~+40°C
 2. Relative Humidity: ≤ 75%RH
 3. Keep away from corrosive atmosphere and sunlight.
- Period of Storage: 1 year